

User Manual

FHD Wireless PTZ Dome IP Camera



Model: FI9928P

Model: FI9938B

Table of Contents

Security Warning.....	1
1 Overview.....	1
1.1 Key Features.....	1
1.2 Read before Use.....	2
1.3 Package Contents.....	2
1.4 Physical Description.....	3
1.5 Micro SD Card Management.....	5
1.6 Instructions for outdoor installation.....	5
2 Access the IP Camera.....	7
2.1 Access the Camera in LAN.....	7
2.2 Access the Camera in WAN.....	7
2.3 Using the VLC Player.....	8
2.4 IP Camera Connection to the Server.....	11
3 Surveillance Software GUI.....	12
3.1 Login Window.....	12
3.2 Setup Wizard.....	13
3.3 Surveillance Window.....	15
4 Advanced Camera Settings.....	23
4.1 Status.....	23
4.2 Basic Settings.....	25
4.3 Network.....	31
4.4 Video.....	41
4.5 Detector.....	45
4.6 Record.....	52
4.7 PTZ.....	55
4.8 Firewall.....	59
4.9 System.....	60
5 Playback.....	64
6 Appendix.....	66
6.1 Frequently Asked Questions.....	66
6.2 Default Parameters.....	74
6.3 Specifications.....	75
6.4 CE & FCC.....	77
6.5 Warranty.....	78
6.6 Statement.....	81
7 Obtaining Technical Support.....	82

Security Warning

- Please change the password of your camera regularly, using a combination of numbers, letters and special characters.
- We recommend that you regularly update your camera to the latest available software and firmware versions to help ensure the best experience for your camera.

1 Overview

FOSCAM camera is an integrated wireless IP camera with a High Definition Color CMOS Sensor enabling viewing resolution 1920 * 1080. It combines a high quality digital video camera, with a powerful web server, to bring clear video to your desktop from anywhere on your local network or over the Internet.

FI9928P supports P2P function. Thanks to the P2P easy access technology, you don't need to do complicated Port Forwarding settings, you just need to scan the QR code on the bottom of the camera to connect it on smart phone, or input the UID on VMS software to realize remote access.

FI9928P supports the industry-standard H.264 compression technology, drastically reducing file sizes and conserving valuable network bandwidth.

The IP camera is based on the TCP/IP standard. There is a WEB server inside which could support Internet Explorer. Therefore the management and maintenance of your device is simplified by using the network to achieve the remote configuration and start-up.

The camera is designed for surveillance applications such as courtyards, supermarket, and school. Controlling the IP camera and managing images are simplified by using the provided web interface across the network utilizing wireless connectivity.

FOSCAM provides Phone apps for Android and iPhone users, please search "Foscam" and install it through app Store, then you can view your camera directly as a computer.

1.1 Key Features

- ◆ Standard H.264 video compression algorithm to satisfy the transmission of high definition video in narrow bandwidth network
- ◆ 2.0 Mega-Pixel
- ◆ P2P feature for easy access
- ◆ Supports Microsoft IE / Mozilla Firefox / Google Chrome / Apple Safari browser or any other standard browsers
- ◆ Supports WPA and WPA2 Encryption

-
- ◆ Wi-Fi compliant with wireless standards IEEE 802.11b/g/n
 - ◆ IR range (Range up to 60m / 196ft)
 - ◆ Supports image snapshot
 - ◆ Supports dual-stream
 - ◆ Supports IR-Cut and the filter change automatically
 - ◆ Supports remote viewing & record from anywhere anytime
 - ◆ Multi-level users management with password protection
 - ◆ Motion detection alert via email or upload image to FTP
 - ◆ Providing Phone apps for Android and iPhone users
 - ◆ Supports multiple network protocols: HTTP / HTTPS / RTSP / TCP/IP / UDP / FTP / DHCP / SMTP / ONVIF
 - ◆ Providing Central Management Software to manage or monitor multi-cameras

1.2 Read before Use

Please first verify that all contents received are complete according to the **Package Contents** listed below. Before the IP camera is installed, please carefully read and follow the instructions in the Quick Setup Guide to avoid damage due to faulty assembly and installation. This also ensures the product is used properly as intended.

1.3 Package Contents

IP Camera * 1	DC Power Adapter * 1
Wi-Fi Antenna * 1	Warranty Card * 1
Quick Setup Guide * 1	

1.4 Physical Description

Front Panel

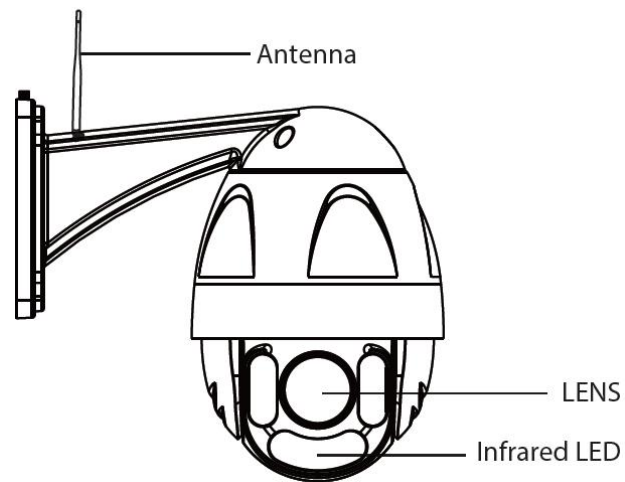

Infrared LED: IR LEDs, IR range up to 60 meters / 196ft.

LENS: High Definition Color CMOS Sensor sensor with zoom lens.

WIFI Antenna: Wireless Antenna

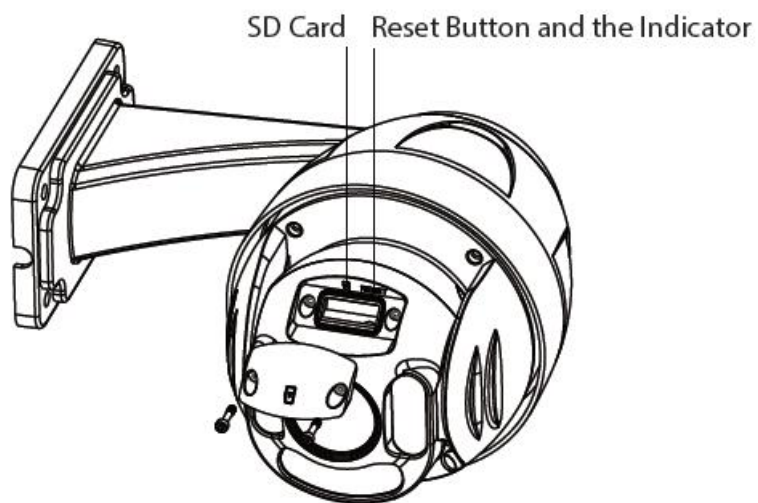

Reset Button

Press and hold on the reset button for 5 seconds. Releasing the reset button, the password will back to the factory default administrator password. The default administrator user is admin with no password.

Interface View



1) I/O alarm terminal block

This network camera provides a I/O alarm terminal block which is used to connect to external input / output device. The pin (there are four number in the terminal block from NO.1 to NO.4) definitions are described below:

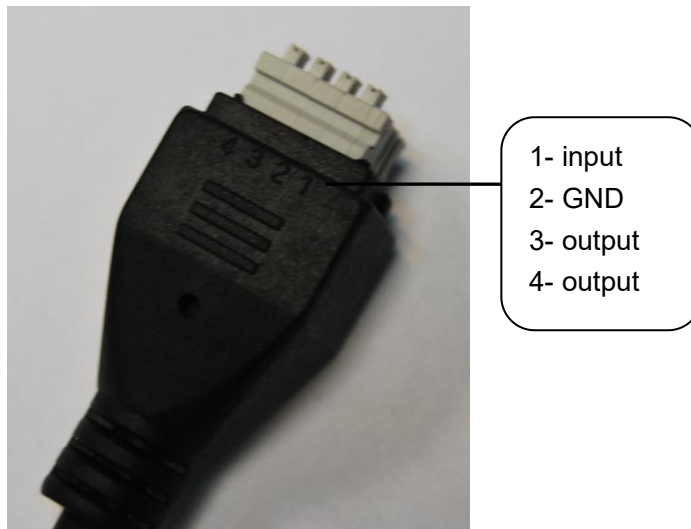

This camera supports I/O alarm, you can go to [4.5.3 I/O Alarm](#) **Settings > Alarm > I/O** page to configure it.

2) Audio Input / Output

- Audio input interface

The jack is used to plug external input device such as sound pick up device directly. Here microphone cannot directly insert to the interface, it must connect to the adapter first.

- Audio output interface

The jack is used to plug external output device such as loud speaker directly. Here microphone cannot directly insert to the interface, it must connect to adapter first.

3) LAN

10/100M adaptive Ethernet interface. Through this interface, IP camera can be connected with various network devices, such as hub, router, etc.

4) Power Interface

Connect the external power adapter, request for 12V/2A power.

Bottom View

There is a QR Code label located on the body of the camera; this is an important feature of original Foscam cameras. If your camera does not have the label, it may be a clone one. Cloned Foscam cameras can not use original firmware and are not eligible for warranty or technical services.

1.5 Micro SD Card Management

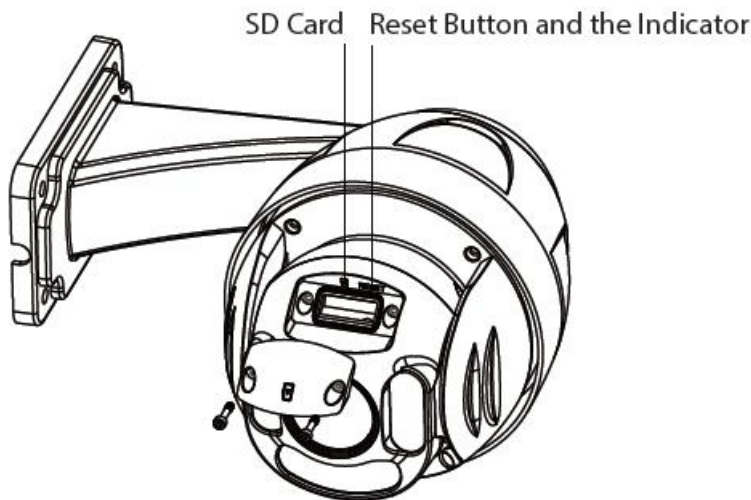

The record files of the IP camera can be stored in the Micro SD Card.

This camera supports Micro SD Card and the max size of Micro SD card must be under 128G.

You need open the cover, then plug the Micro SD card into Micro SD card slot inside the IP camera.

When you plug in the Micro SD card during the camera work process, please reboot the camera again, or else the Micro SD Card may be cannot work well. When you re-install the cover, please ensure the tightness with the camera.

Warning: Please lock the cover in time after installing the Micro SD card to avoid water or water vapor fall into the equipment then cause damage or lens fog.

1.6 Instructions for outdoor installation

The cable of an outdoor camera should, from the position where the cable is divided into several cables, be fitted dry. Install the cable into a waterproof junction box (1) or bring the cable indoors (2).

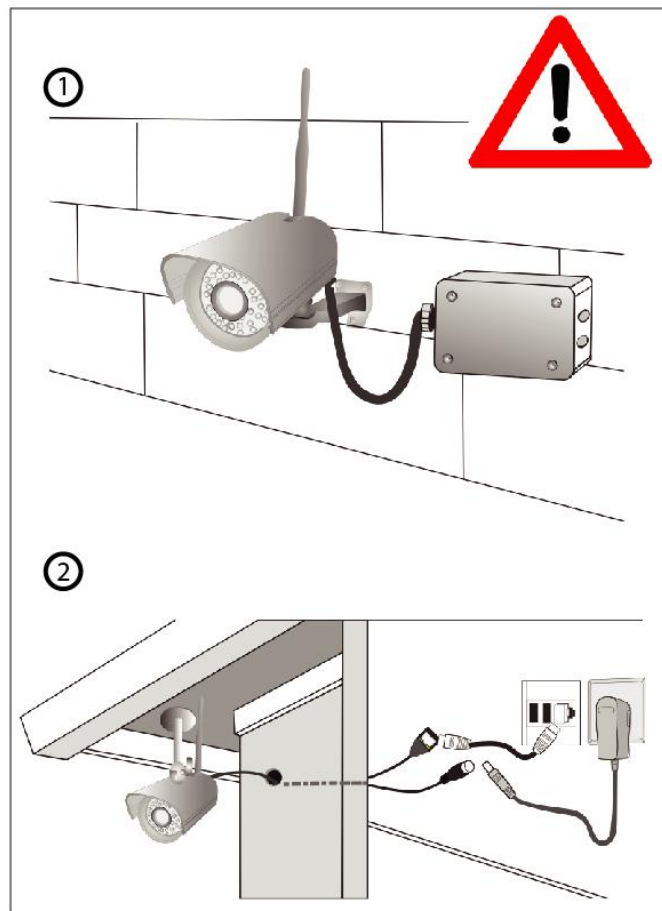

2 Access the IP Camera

This chapter explains how to access the camera through browser and RTSP player.

2.1 Access the Camera in LAN

This camera supports HTTP and HTTPS protocols, you can access the camera by two ways.

(1) http:// LAN IP + HTTP Port NO.

Double click the Equipment Search Tool icon and it should find the camera's IP address automatically after you plug in the network cable.

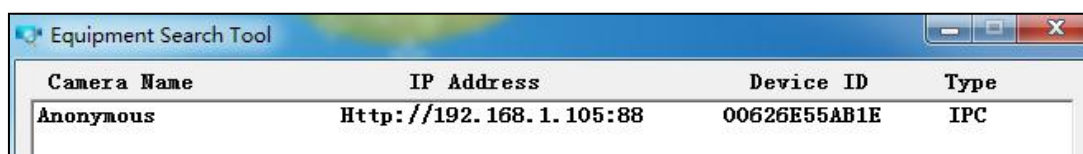

Camera Name	IP Address	Device ID	Type
Anonymous	Http://192.168.1.105:88	00626E55AB1E	IPC

Double click the IP address of the camera; your default browser will open to the camera login page.

(2) https:// LAN IP + HTTPS Port NO.

The default Https port NO. is 443. You can use the url to access the camera: **https:// LAN IP + HTTPS port**. Go to [4.3.5 Port Settings](#) > **Network** > **Port** panel, you can see and change the https and https port NO.



Port Type	Port Number
HTTP Port	88
HTTPS Port	443
ONVIF Port	65533

2.2 Access the Camera in WAN

2.2.1 Static IP Addresses

Users with static IP addresses after you have finished connecting the camera using the LAN IP address and port forwarding, you can access the camera directly from Internet using the WAN IP address and port number.

How to Obtain the WAN IP address from a public website ?

To obtain your WAN IP address, enter the following URL in your browser: <http://www.whatismyip.com>.The

webpage at this address will show you the current WAN IP.



Access your IP Camera from the Internet

You can access the IP camera from the Internet (remote access). Enter the WAN IP address and port number in your standard browser. For example, you would enter `http:// 183.37.28.254:85`

NOTE:

Make sure port forwarding is successful. You can do port forwarding two ways.

1. Login to your router to enable the "UPNP" function. You can then login to the camera as administrator, choose Network, and then choose UPnP to enable UPnP. Make sure that the status of UPnP reads "UPnP Successful" on the Device Status page.
2. Do port (HTTP port) forwarding manually.

If your router has a Virtual Server, it can do port forwarding. Add the camera's LAN IP and port which you had set earlier to your router's port forwarding settings.

2.3 Using the VLC Player

This camera supports RTSP streaming, here you can view the camera using VLC player.

RTSP URL [rtsp:// \[user name\]:password@IP:HTTP port number/videosream](rtsp:// [user name]:password@IP:HTTP port number/videosream)

The part in the square brackets may be omitted.

user name & password: The user name and password to access the camera. This part can be omitted.

IP: WAN or LAN IP address.

Video stream: Here support three mode: videoMain, videoSub and audio. When the network speed is bad, here you had better select videoSub. If you select audio, you can only hear the sound but cannot see the video.

For example:

IP: 192.168.1.11

HTTP Port number: 88

User name: admin

Password: 123

Here I can enter one of the following URLs in the VLC.

- 1) `rtsp://admin:123@192.168.1.11:88/videoMain`
- 2) `rtsp:// @192.168.1.11:88/videoMain`
- 3) `rtsp://:123@192.168.1.11:88/videoMain`
- 4) `rtsp://admin@192.168.1.11:88/videoMain`

Open the VLC, and go to Media > Open Network Stream option, then enter the URL into VLC.

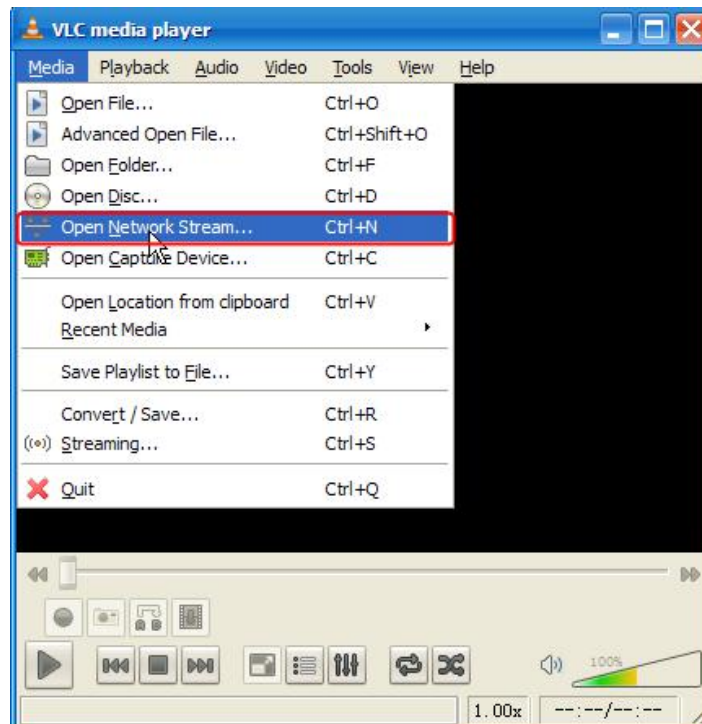

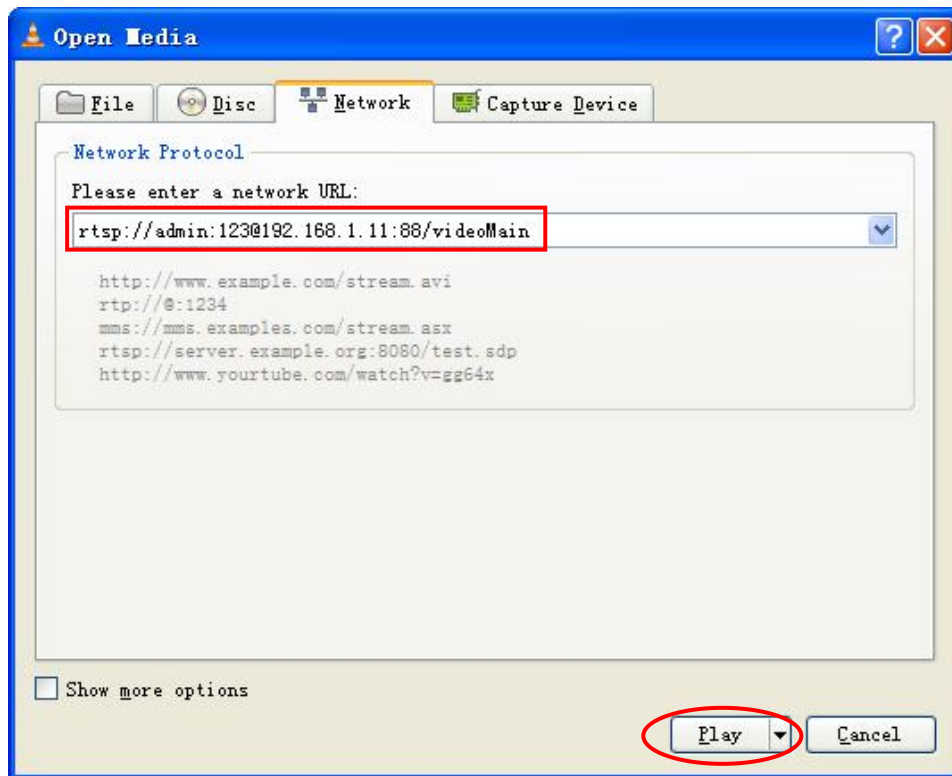

Sometimes you may need to enter the user name and password again. Click OK and you can see the real-time preview.



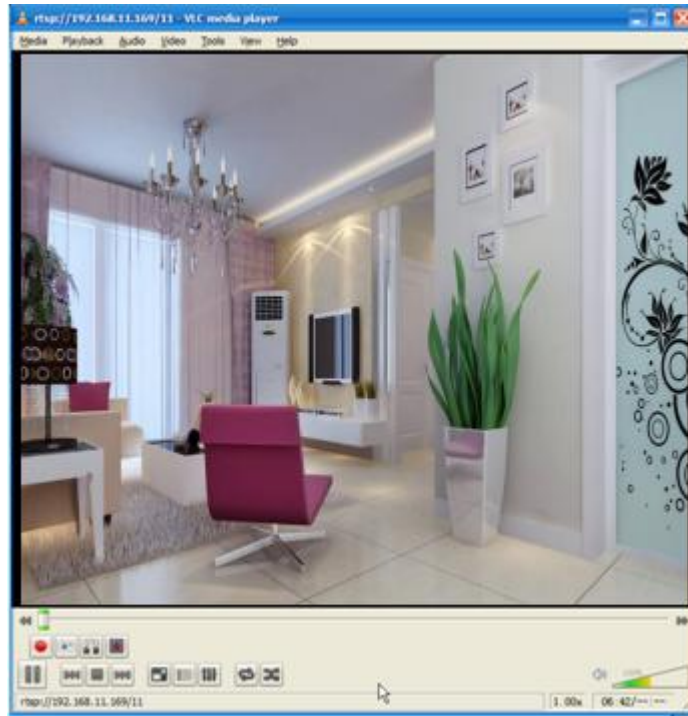

If you cannot play the video in the VLC player, please check the port mapping.

NOTE:

If you modify the camera's username or password, you had better reboot the camera, or else the new username and password cannot take effect when you enter the authentication in the VLC.

2.4 IP Camera Connection to the Server

Device supports ONVIF2.2.1 protocol, You can easily access the NVR with ONVIF or server with ONVIF.

3 Surveillance Software GUI

Please refer to the Quick Setup Guide if you install the camera at first time. After finishing quick installation, you can take time to learn the operation of the software.

3.1 Login Window

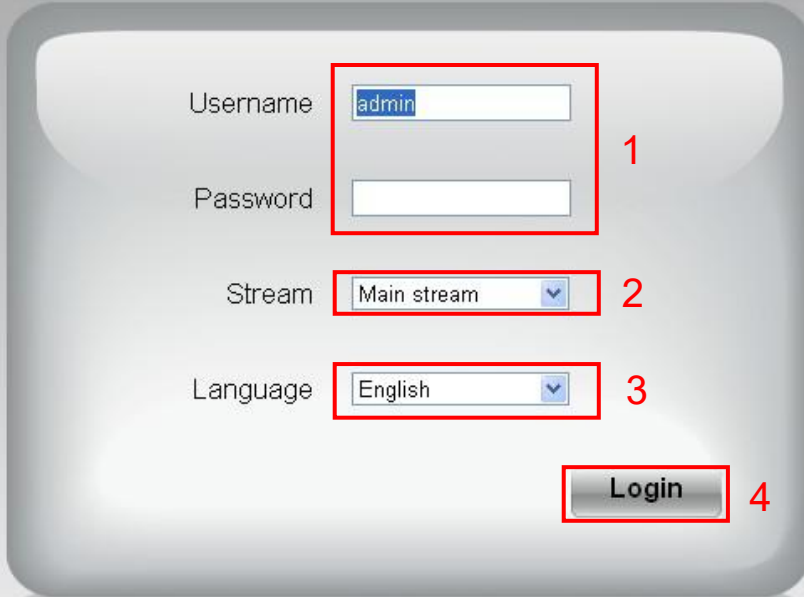

The screenshot shows a login window with the following fields and controls:

- Username:** A text input field containing the text "admin". A red box highlights this field, with the number "1" to its right.
- Password:** A text input field that is currently empty. A red box highlights this field, with the number "1" to its right.
- Stream:** A dropdown menu showing "Main stream". A red box highlights this dropdown, with the number "2" to its right.
- Language:** A dropdown menu showing "English". A red box highlights this dropdown, with the number "3" to its right.
- Login:** A button labeled "Login". A red box highlights this button, with the number "4" to its right.

Section 1 Enter the User name and password

The default administrator username is admin with a blank password, please reset the password at first using and prevent unauthorized users login the camera.

Section 2 Stream

The camera supports two stream modes: Main stream and sub stream. If you want to access the camera form LAN, here you can select Main stream. If you want to access the camera from Internet, here we recommend sub stream.

NOTE: When the network bandwidth is badly you'd better select Sub Stream and the video will be more fluency.

Section 3 Select the language

You can select the language you need via click on the language dropdown list to switch.

Section 4 Login the camera

Click **Login** button and you will see the surveillance windows. (If login the camera for the first time, the page that modify the username and password will appears.)

3.2 Setup Wizard

After logging in for the first time, you will go to "Setup Wizard" automatically. Here you can set the basic parameters of camera, such as the country, camera name, camera time, wireless settings, IP configuration.



The screenshot shows the "Setup Wizard" interface. At the top, the title "Setup Wizard" is displayed in blue. Below it, a light blue header bar contains the text "Setup Wizard - Start". The main content area has a light gray background and contains the following text: "Follow the guide to set your camera, click 'Next' to start." and "Please click the menu on the left for more settings." At the bottom center, there is a "Next" button.

Country: Select the country.



The screenshot shows the "Setup Wizard" interface at "Step 1 of 5 - country". The title "Setup Wizard" is at the top. The header bar says "Step 1 of 5 - country". On the left, a light blue box contains the label "country". To the right, there is a dropdown menu with "America" selected. Below the dropdown, the text reads: "Please select the country where you live to ensure a better video experience for you." At the bottom, there are "Previous" and "Next" buttons.

Device Name: You could name your camera.



The screenshot shows the "Setup Wizard" interface at "Step 2 of 5 - Camera Name". The title "Setup Wizard" is at the top. The header bar says "Step 2 of 5 - Camera Name". On the left, a light blue box contains the label "Camera Name". To the right, there is a text input field containing "F19928P". Below the input field, the text reads: "The maximum Device Name length is 20, support English, numbers, letters and symbols". At the bottom, there are "Previous" and "Next" buttons.

System Time: Select the time zone you need to set the date, time, format and so on.

The screenshot shows the 'Setup Wizard' interface for 'Step 3 of 5 - Camera Time'. It includes a 'Time Zone' dropdown set to '(GMT) Greenwich mean time; London, Lisbon', a checked 'Sync with NTP server' option, an 'NTP Server' dropdown set to 'Auto', a 'Device Time' section with a date field (2016-9-7) and time fields (09:18:38) and a 'Sync with PC/Terminal' button, 'Date Format' (YYYY-MM-DD) and 'Time Format' (24-hour) dropdowns, a checked 'use DST' option, and DST start/end dates (April first Sunday 2:00 to October the last one Sunday 2:00) and 'Ahead Of Time' (0 Minute). 'Previous' and 'Next' buttons are at the bottom.

Wireless networks: Click **Scan**, find the SSID of your wireless router, select and enter the password.

The screenshot shows the 'Setup Wizard' interface for 'Step 4 of 5 - Wireless Settings'. It features a 'Wireless Network List' table with columns for SSID, Encryption, and Quality. A 'Scan' button is highlighted with a red box and a '1'. The 'product-2.4GHz' row is highlighted in green with a '2'. To the right, a form contains 'SSID' (product-2.4GHz), 'Encryption' (WPA/WPA2), and 'Password' (masked with dots) fields, with the password field highlighted by a red box and a '3'. A note below the password field states: 'The maximum password length is 63, including numbers, letters and symbols'. 'Previous' and 'Next' buttons are at the bottom.

SSID(Network Name)	Encryption	Quality
ADlink-heng	WPA/WPA2	📶
fusha+TP-LINK_403E	WPA/WPA2	📶
app_net	WPA/WPA2	📶
APP210	WPA/WPA2	📶
product-2.4GHz	WPA/WPA2	📶
TP-LINK_3742	WPA/WPA2	📶
docdev2	WPA/WPA2	📶
TP-LINK_A5DC	Unencrypt	📶
Hi-WiFi-1307	WPA/WPA2	📶
1234567890987654321	WPA/WPA2	📶

IP: Set IP address of the camera. You could choose to obtain an IP automatically or set the IP address according to your needs.

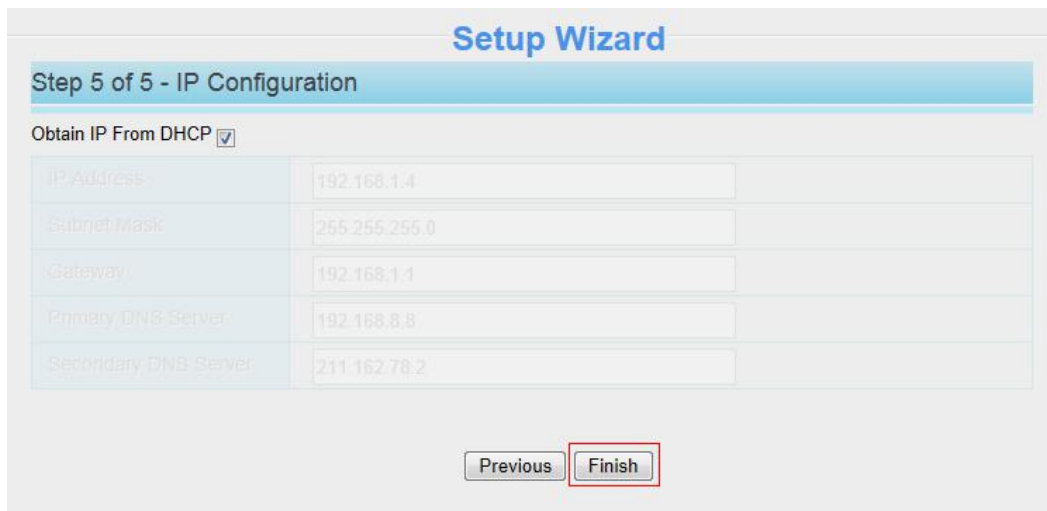

3.3 Surveillance Window

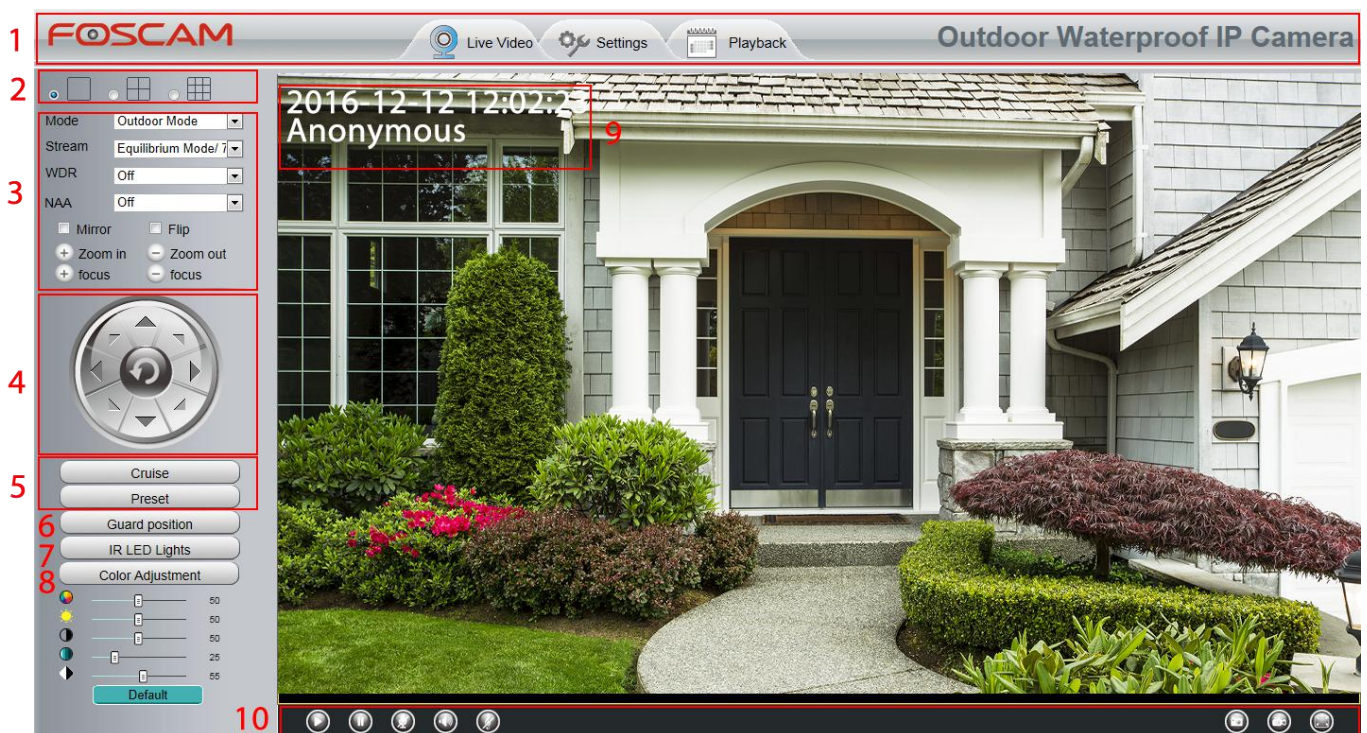

Section 1 FOSCAM Logo / LiveVideo / Settings / Playback Buttons

FOSCAM: FOSCAM LOGO

LiveVideo: Path to surveillance window. Click this button and back to the surveillance window

Settings: Path to Administrator Control Panel, Click it, and it will lead to Administrator Control Panel and do advanced settings.



: Click this button and back to the Playback panel to view the record files stored in the SD Card.

Section 2 Multi-Device Window

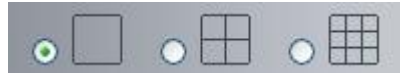

The firmware inside the camera supports up to maximum of 9 cameras being monitoring at the same time. You can add other cameras in multi-device setting.

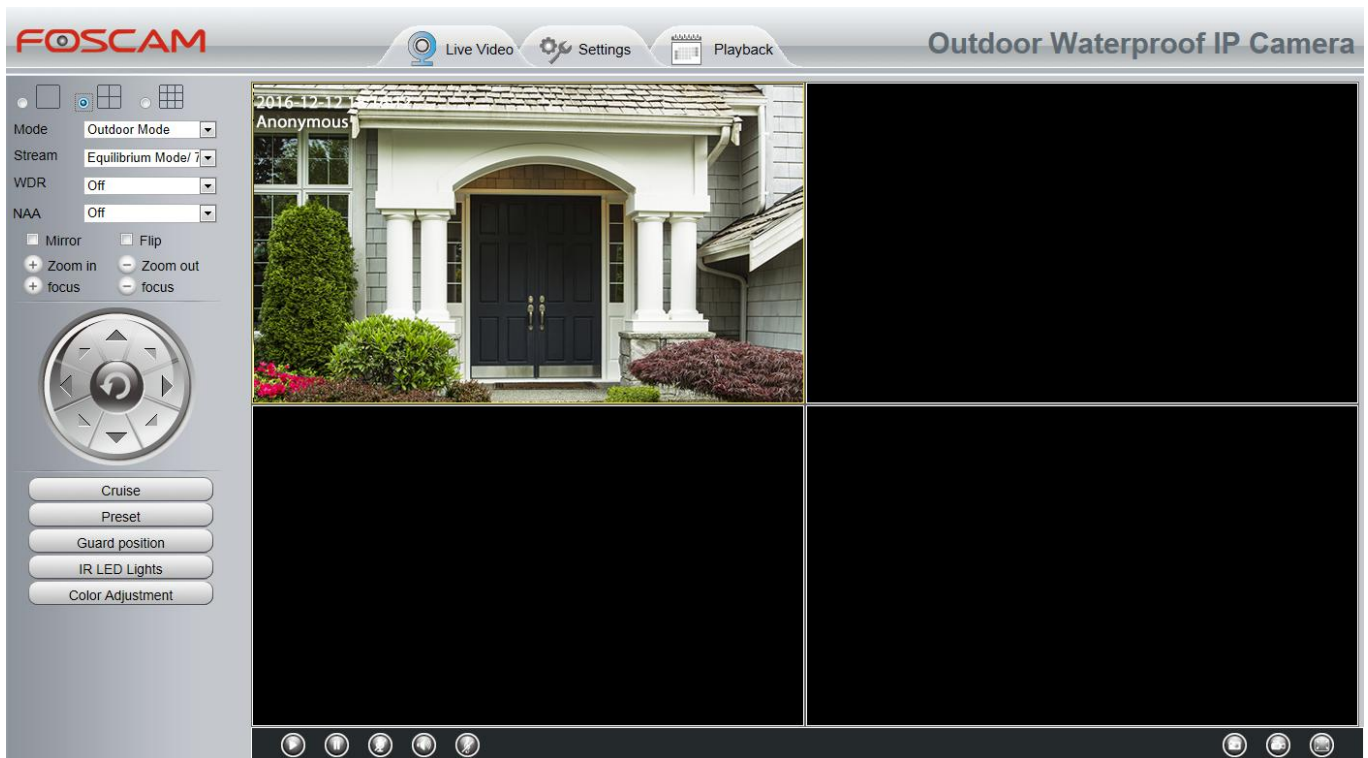

Section 3 Mode / Stream / WDR / NAA / Mirror / Flip / Zoom / Focus Buttons

Mode

- 1) 50HZ ----- Indoor surveillance (Region: Europe, China)
- 2) 60HZ ----- Indoor surveillance (Region: USA, Canada)
- 3) Outdoor Mode ----- Outdoor surveillance

Stream

The default stream supports multiple modes, For example: HD Mode / 1080P / 15fps / 1M meanings: Stream type / Resolution / Maximum frame rate / Bit rate. (Different models support different specific mode.)

1) Stream type: It is used to identify the stream type.

2) 1080P / VGA

There are two resolutions, the bigger one is 1080P, and the smaller one (VGA) is 640x480 pixels. The bigger the resolution, the better of the image quality is. If you are accessing the camera via internet and want to get more fluent video streaming, please select resolution VGA.

3) Maximum frame rate

When the video format is 50Hz, the maximum frame rate is 25 fps. When the video format is 60Hz, the maximum frame rate is 30 fps. You should lower frame rate when the bandwidth is limited. Normally, when the



frame rate above 15, you can achieve fluently video.

4) Bit rate

Generally speaking, the larger the bit rate is, the clearer video will become. But the bit rate configuration should combine well with the network bandwidth. When the bandwidth is very narrow, and bit rate is large, that will lead to video cannot play well.

You can reset the stream type on **Settings > Video > Video Settings** panel.
After changing, please re-login the camera and you can see the modification.

Zoom In or Zoom Out

Device Support zoom feature, click  or , The focal length of the camera lens will be larger or shrink, you can adjust the focus distance to the target object size, access to high-definition screen.

Focus

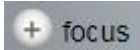
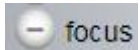
You can manually adjust the focus by clicking on the button  or .

Section 4 Pan / Tilt Control

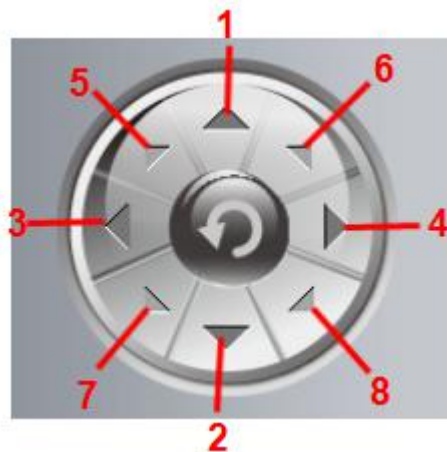

1	Up control button	2	Down control button
3	Left control button	4	Right control button
5	Up-Left control button	6	Up-Right control button
7	Down-Left control button	8	Down-Right control button



Click this button and go to center.

Section 5 Cruise / Preset settings



Cruise Settings



The default cruise tracks have two types: Vertical and Horizontal.

Vertical: The camera will rotate from up to down.

Horizontal: The camera will rotate from left to right.

: Start cruise. : Stop cruise.

If you want to define or change the cruise trace, please go to **Settings > PTZ > Cruise Settings** panel.

How to do cruise?

Firstly: Select one track in the track dropdown list



Secondly: Click **Start** cruise button, the camera will cruise following the predefined path.

Thirdly: Click **Stop** button and finish cruising.

Preset settings



IP camera supports 16 preset positions, which is considered enough for DIY home & small business surveillance market

The default preset position is Topmost, Bottom most, Left most, right most, you can add other preset positions.

 **Add** Click this icon to save the position you need the camera to remember.

 **Delete** Select one preset position and click this button to delete it.

 **GO** Select one preset position in the preset dropdown list and click Go to make the camera move the preset position

How to do preset position?

Firstly, move the camera and stop at a desired place where you want make preset position.

Secondly, click  button and enter a descriptive name for the preset position. The preset position cannot contain special characters. Then click **OK** to save it. If you want to reset the preset position, click **Cancel**.

After that, you can move the camera and stop at another place, and set another preset position. You can do all the 16 preset positions with this method.

If you want to see one preset position you have set, only select the preset position name from the preset dropdown list, and click go  button, the camera will go to the preset position.

Section 6 Guard Position

After setting the guard position, your camcorder will automatically return to the guard position within a predetermined time (manually setting) when it stops moving (manually or cruise). You could refer to the following method in [4.7.4 Guard Position Settings](#).

Section 7 IR LED Lights

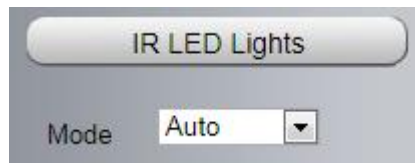

Click Infra led and there are three modes to adjust the infrared led: Auto, Manual and Schedule.

Auto: Select it and the camera will adjust the infra led (on or off) automatically.

Manual: Select it and you can turn on or turn off the infra led manually.

Schedule: Scheduled control. When it is selected, the function of switching on / off the infrared lamp as scheduled is enabled (**Settings > Video > IR LED Schedule**).

Section 8 Image Quality Settings

In this page, you can tune Hue, Brightness, Contrast, Saturation, and Sharpness to get higher quality.



Section 9 OSD

If you have added time and camera name in the video, you can see it in the live window.

Go to **Settings > Basic Settings > Camera Name** panel, and you can change another device name. The default device name is anonymous.

Go to **Settings > Basic Settings > Camera Time** panel and adjust the device time.

Go to **Settings > Video > On Screen Display** panel, you can add OSD or not.

Section 10 Play / Stop / Talk / Audio / Snap / Record / Full Screen Button



1----- Play Click it to play the video of the camera

2----- Stop Click it to stop the video of the camera

3----- Talk Click the button and the icon will become to , then talk to the microphone that connected with PC, people around the camera can here your voice. Click the icon again and stop talking.

4----- Audio Click this icon, the icon will become to  you can hear the sound around the camera by the earphone or speakers that connected with PC.

5----- Volume Click it to open the volume control.

6----- Snapshot Click it to make snapshot and it pop-up a window which picture you snapshot, right click in the window and save the picture to anywhere you want.

7----- Record Click the icon  and the camera start recording, you can see a green dot in the live window. Click again and stop recording. The default storage path is C:\IPCamRecord. You can change the storage path: Go to **Settings > Record > Storage Location**.

8----- Full Screen Click it to make full-screen, or you can double click the surveillance screen to make full-screen. Double click again and exit full-screen.

Onscreen Mouse Control

Right click the mouse and you can adjust the screen ration, full screen and Zoom up.

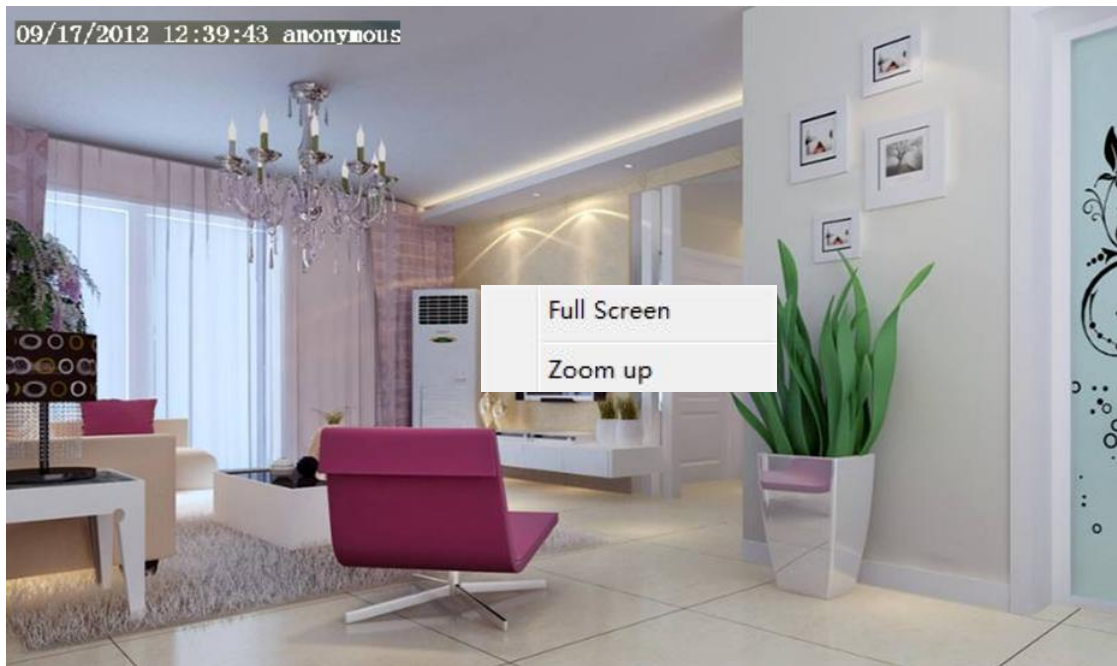

Full Screen: Select it and click it to make full-screen, press **ESC** and exit full-screen.

Zoom Up

First Method: Here is a convenient and fast solution to Zoom up / down screen by clicking Video Screen and adjusting Mouse pulley, or by press the CTRL key and click the mouse left button.

Second Method: Click it and the live view will be digital zoomed up, then click **Zoom Down** and the live view back to original size.



When you select the **Full Screen**, then click right mouse, there is a **Screen PTZ** button.

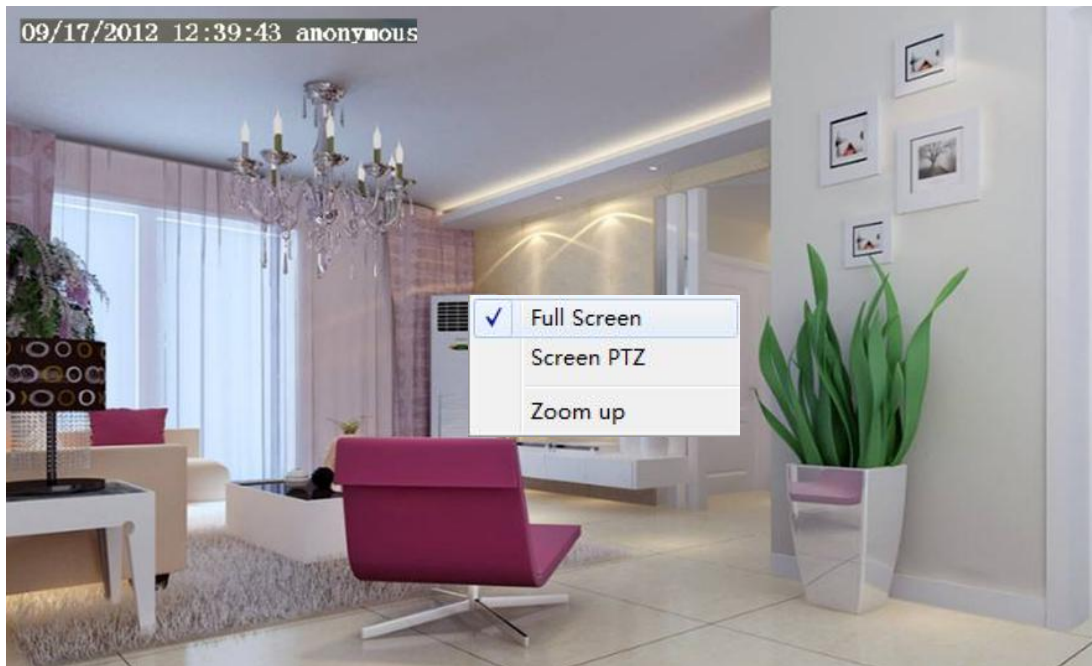

Click the **Screen PTZ** button and put the mouse on the screen to indicate the camera move direction you prefer, press the left mouse, the camera will move to the corresponding direction. Loosen the mouse and stop moving. Press **Esc** button or double click right mouse and cancel the function.

NOTE:

For Mac OS, the plugin cannot support Onscreen Mouse Control, so you cannot allow to use it.

4 Advanced Camera Settings

Click the button **Settings**, go to Administrator Control Panel to make advanced camera settings.

4.1 Status

Status contains four columns: Device Information, Device Status, Session Status and Log, it will show you various information about your camera.

4.1.1 Device Information

Device Information	
Camera Model	FI9928P
Camera Name	Anonymous
Camera ID	A0E21555C336
Camera Time	2016/10/09 08:25:21
System Firmware Version	1.11.1.8
Application Firmware Version	2.74.1.32
Plug-In Version	3.3.0.26

Camera Model: The model of the device.

Camera Name: The Device Name is a unique name that you can give to your device to help you identify it. Click **Basic Settings** and go to **Camera name** panel where you can change your camera name. The default device name is the camera model.

Camera ID: Display the wired MAC address of your camera.

Camera Time: The system time of the device. Click **Basic Settings** > **Camera time** panel and adjust the time.

System Firmware Version: Display the system firmware version of your camera.

Application Firmware Version: Display the application firmware version of your camera.

Plug-In Version: Display the plug-in version of your camera

4.1.2 Device Status

On this page you can see device status such as Motion Alarm status, Sound Alarm Status, Record Status, SD Card Status and so on.

Device Status	
Refresh	
Motion alarm status	No alarm
Sound alarm status	Disabled
Human Detection Alarm Status	Disabled
Recording Status	Not Recording
SD Card Status	No SD card
SD Card Free Space	0KB
SD Card Total Space	0KB
NTP Status	Failed
WiFi Status	Connected to: Xiaomi_49AB
IR LED Status	On

4.1.3 Session Status

Session status will display who and which IP is visiting the camera now.

Session Status	
Refresh	
Username	IP Address
1	192.168.1.3

4.1.4 Log

The log record shows who and which IP address accessed or logout the camera and when reboot the camera and clear the log records.

Log				
Pages: 1				
NO.	Time	User	IP	Log
1	2016-10-09 08:36:12	root	127.0.0.1	Detected motion alarm
2	2016-10-09 08:32:16	1	192.168.1.3	Login
3	2016-10-09 08:32:07	admin	192.168.1.3	Log out
4	2016-10-09 08:31:56	admin	192.168.1.3	Login
5	2016-10-09 08:30:31	root	127.0.0.1	Detected motion alarm
6	2016-10-09 08:30:12	root	127.0.0.1	System startup

4.2 Basic Settings

This section allows you to configure your camera's Name, Time, User Account and Multi-Camera.

4.2.1 Camera Name

Default alias is anonymous. You can define a name for your camera here such as **Anonymous**. Click **Save** to save your changes. The alias name cannot contain special characters.

Camera Name	
Camera Name	<input type="text" value="Anonymous"/> <p>The maximum Device Name length is 20, support English, numbers, letters and symbols</p>

4.2.2 Camera Time

This section allows you to configure the settings of the internal system clocks for your camera.

Camera Time

Time Zone	(GMT) Greenwich mean time; London, Lisbon, ▾		
Sync with NTP server <input checked="" type="checkbox"/>			
NTP Server	Auto ▾		
Device Time:	2016-10-9	08 ▾	43 ▾ 03 ▾
<input type="button" value="Sync with PC/Terminal"/>			
Date Format	YYYY-MM-DD ▾		
Time Format	24-hour ▾		
use DST <input checked="" type="checkbox"/>			
From	April ▾	first ▾	Sunday ▾ 2 ▾ : 0 0
To	October ▾	the last one ▾	Sunday ▾ 2 ▾ : 0 0
Ahead Of Time	0 ▾	Minute	

Time Zone: Select the time zone for your region from the dropdown menu.

Sync with NTP server: Network Time Protocol will synchronize your camera with an Internet time server. Choose the one that is closest to your camera.

Sync with PC: Select this option to synchronize the date and time of the Network Camera with your computer.

Manually: The administrator can enter the date and time manually. Please select the date and time format.

Use DST: Select the **Use DST**, then select the daylight saving time from the dropdown menu.

Click **Save** button to submit your settings.

NOTE: If the power supply of camera is disconnect, you need set the camera's time again.

4.2.3 User Accounts

Here you can create users and set **Privilege, Visitor, Operator** or **Administrator**. The default user account is Administrator, with a blank password. You can enter the users accounts of visitor, operator and administrator Manually.

User Accounts

 Refresh

NO.	Username	Privilege
1	1	Administrator
2		
3		
4		
5		
6		
7		
8		

Username

Privilege

The maximum username length is 20, including numbers, letters and symbols _ - @ \$ *
 Password should be 6-12 numbers, letters, symbols combination, support ~ ! @ # % ^ * () _ + { } : " | < > ? ` ~ ; ' \ , . /

How to change the password of administrator?

Firstly, select the account of administrator, then select **Change password**, enter the old password and the new password, lastly click **Modify** to take effect.

User Accounts

 Refresh

NO.	Username	Privilege
1	1	Administrator
2		
3		
4		
5		
6		
7		
8		

Username

Password

New password

Security Level

Confirm the password

Privilege

Change username

Change password

The maximum username length is 20, including numbers, letters and symbols _ - @ \$ *
 Password should be 6-12 numbers, letters, symbols combination, support ~ ! @ # % ^ * () _ + { } : " | < > ? ` ~ ; ' \ , . /

How to add account ?

Select one blank column, then enter the new user name, password and select the privilege, last click **Add** to take effect. You can see the new added account on the Account list.

User Accounts

Refresh

NO.	Username	Privilege
1	1	Administrator
2		
3		
4		
5		
6		
7		
8		

Username:
 Password:
 Security Level:
 Confirm the password:
 Privilege:

Add

The maximum username length is 20, including numbers, letters and symbols _ - @ \$ *
 Password should be 6-12 numbers, letters, symbols combination · support ~ ! @ # % ^ * () _ + { } : " | < > ? ` - ; ' \ , . /

User Accounts

Refresh

NO.	Username	Privilege
1	1	Administrator
2	Operator	Administrator
3		
4		
5		
6		
7		
8		

Username:
 Privilege:

Change username
 Change password

Delete

The maximum username length is 20, including numbers, letters and symbols _ - @ \$ *
 Password should be 6-12 numbers, letters, symbols combination · support ~ ! @ # % ^ * () _ + { } : " | < > ? ` - ; ' \ , . /

Delete: Select the account which you want to delete, then click **Delete** button to take effect.

NOTE: The default admin account cannot be deleted, but you can add other administrator users.

How to change the username ?

Firstly, select the account which you want to change the username, then select **Change Username**, enter the new password, lastly click **Modify** to take effect.

User Accounts

NO.	Username	Privilege
1	1	Administrator
2	Operator	Administrator
3		
4		
5		
6		
7		
8		

Username:

New username:

Privilege:

Change username

Change password

The maximum username length is 20, including numbers, letters and symbols - @ \$ *
 Password should be 6-12 numbers, letters, symbols combination, support ~ ! @ # % ^ * () _ + { } : " | < > ? ` ' \ , . /

4.2.4 Multi-Camera

If you want to view multi-surveillance screens on one window, you need to login one camera, and set it as the main device, and do Multi-Device Settings, add other cameras to the first one camera. Before you do multi-cams settings, you need to assign different port such as 81, 82, 83, 84, 85, 86, 87, 88 to the cameras if there is 8 cams installed.

The firmware within the camera can support a maximum of 9 devices monitoring all at the same time. This page you can both add FOSCAM MJPEG and H.264 series cameras to the first camera and view multi-surveillance screen on one window.

Add Cameras on LAN

In Multi-Device Settings page, you can see all devices searched on LAN. The 1st Device is the default one. You can add more cameras in the list in LAN for monitoring. The camera's software supports up to 9 IP cameras online simultaneously. Click **The 2nd Device** and click the item in the **Device List in LAN**, the name, host and Http port will be filled in the boxes below automatically. Enter the correct username and password then click **Add**. Add more cameras in the same way.

Cameras On LAN	
	anonymous(192.168.11.193) F19821W for ebuyer (192.168.11.241) anonymous(192.168.11.203) anonymous(192.168.11.243)
The 1st Camera	This Camera
The 2nd Camera	None
Camera Model	MJ
Camera Name	anonymous
Host	192.168.11.203
HTTP Port	80
Media Port	80
Username	admin
Password	
	<input type="button" value="Add"/> <input type="button" value="Delete"/>
The 3rd Camera	None
The 4th Camera	None

1. Click it, camera model, alias, host and HTTP Port will be filled in the following boxes automatically.

2. Enter the User name and password of the 2nd camera.

3. Click Add to take effect.

Camera Model: Our Company produces two series cameras: MJ and H.264. Here will show you which series the camera belongs to.

Cameras On LAN	
	anonymous(192.168.11.193) F19821W for ebuyer (192.168.11.241) anonymous(192.168.11.203) anonymous(192.168.11.243)
The 1st Camera	This Camera
The 2nd Camera	anonymous(192.168.11.203)
The 3rd Camera	F19821W for ebuyer (192.168.11.241)
The 4th Camera	anonymous(192.168.11.203)
The 5th Camera	None
The 6th Camera	None
The 7th Camera	None
The 8th Camera	None
The 9th Camera	None

Note: If you want to access your camera remotely, make sure you are able to access it seperately through a browser.

Back to **Surveillance Windows**, and click Four Windows option, you will see four cameras you added.

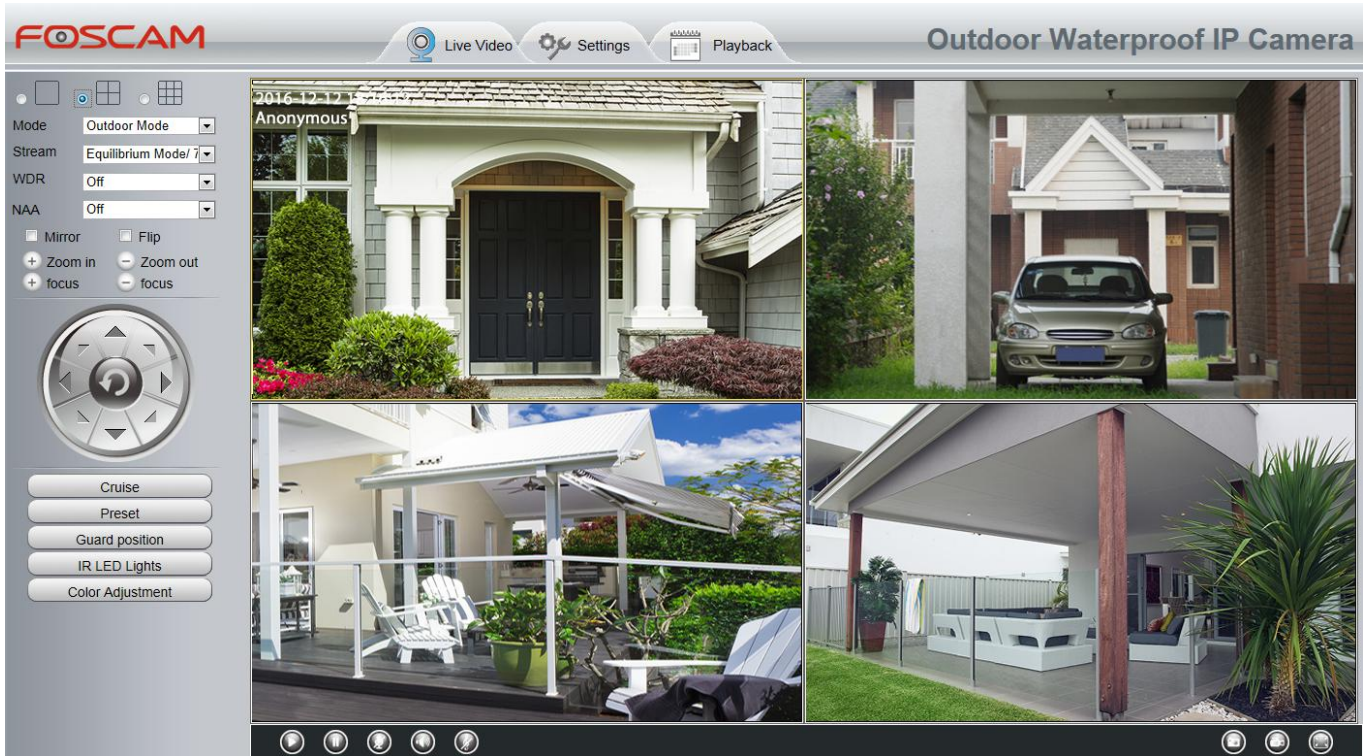

4.2.5 Voice Prompt

On this page, you can enable or disable voice prompt. Select “Yes” to enable or select “No” to disable. If select “Yes”, you can hear the voice prompt after connect the audio output device.



4.3 Network

This section will allow you to configure your camera's IP, Wireless Settings and Port.

4.3.1 IP Configuration

If you want to set a static IP for the camera, please go to **IP Configuration** page. Keep the camera in the same subnet of your router or computer.

IP Configuration

Obtain IP From DHCP

IP Address	192.168.1.2
Subnet Mask	255.255.255.0
Gateway	192.168.1.1
Primary DNS Server	192.168.8.8
Secondary DNS Server	211.162.78.2

Changing settings here is the same as using the Equipment Search Tool.

It is recommended that you use the subnet mask, gateway and DNS server from your locally attached PC. If you don't know the subnet mask, gateway and DNS server, you can check your computer's local area connection as follows:

Control Panel > Network Connections > Local Area Connections > Choose Support > Details.

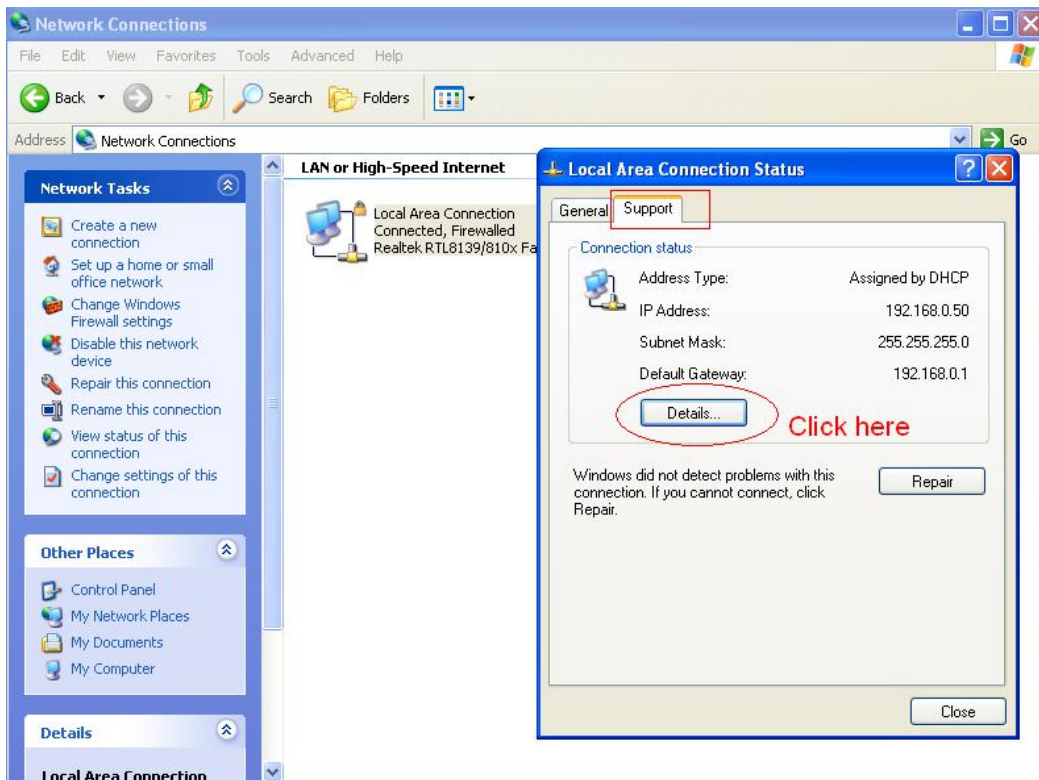

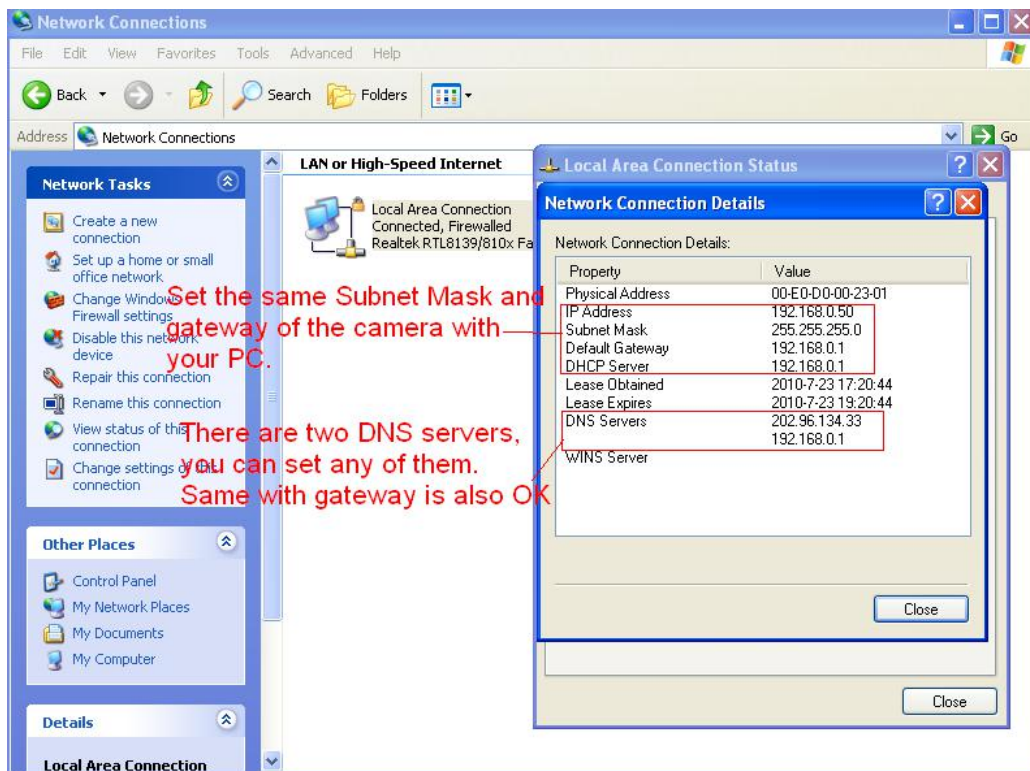

If you don't know the DNS server, you can use the same settings as the Default Gateway.

4.3.2 Wireless Settings

Step 1 Choose **Settings > Network > Wireless Settings**.

Click the **Scan** button and the camera will detect all wireless networks around the area. It should also display your router in the list.

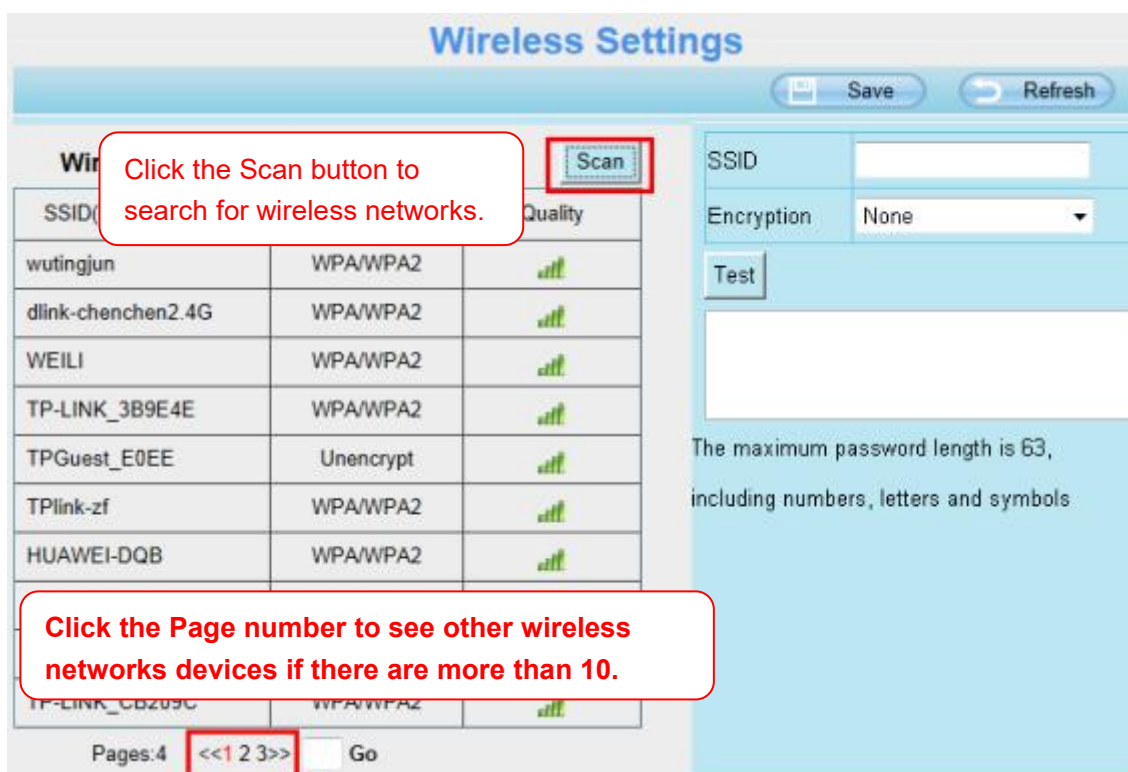

Step 2: Click the SSID (name of your router) in the list, the corresponding information related to your network, such as the name and the encryption, will be filled into the relevant fields automatically.

You will only need to fill in the password of your network. Make sure that the SSID, Encryption and the password you filled in are exactly the same for your router.



Step 3: Please click on the **Save** button after all settings have been entered and disconnect the network cable. Never shut down the power of the camera until the IP camera is able to connect to the wireless network.

The LAN IP address will disappear on the window of Equipment Search Tool when the camera is configuring a wireless connection. Wait about 1 minute, the camera should obtain a wireless connection, and the LAN IP of the camera will show again on the window of the Equipment Search Tool. The IP address may have changed after the camera receives a wireless connection; we recommend setting a static local IP address if this IP address changes by right clicking the camera in Equipment Search Tools, setting a static IP, and pushing OK. Congratulations! You have set up the wireless connection of the camera successfully.

NOTE:

If you fail to make a wireless connection, please refer to your seller or contact us directly for assistance.

4.3.3 Port

This camera supports HTTP Port. HTTP Port is used to access the camera remotely. If you want to access the camera and view the video, the HTTP Port must both be configured correctly.

HTTP Port: By default, the HTTP port is set to 88. Also, they can be assigned with another port number between 1 and 65535. But make sure they can not be conflict with other existing ports like 25, 21.



The 'Port' configuration window displays a table with the following data:

Port Type	Port Number
HTTP Port	88
HTTPS Port	443
ONVIF Port	888

Another way to change the HTTP port NO.

Step 1, Open the Equipment Search Tool, select the camera you would like to change the port of, right click on the IP address, and click on **Network Configuration**, this brings up the network configuration box as shown in following figures.

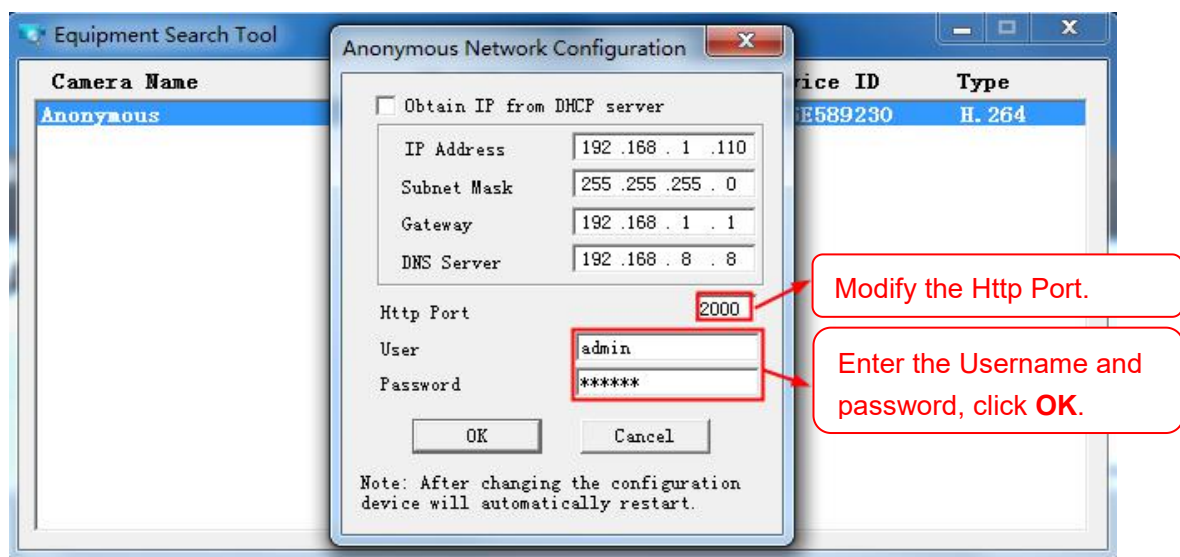
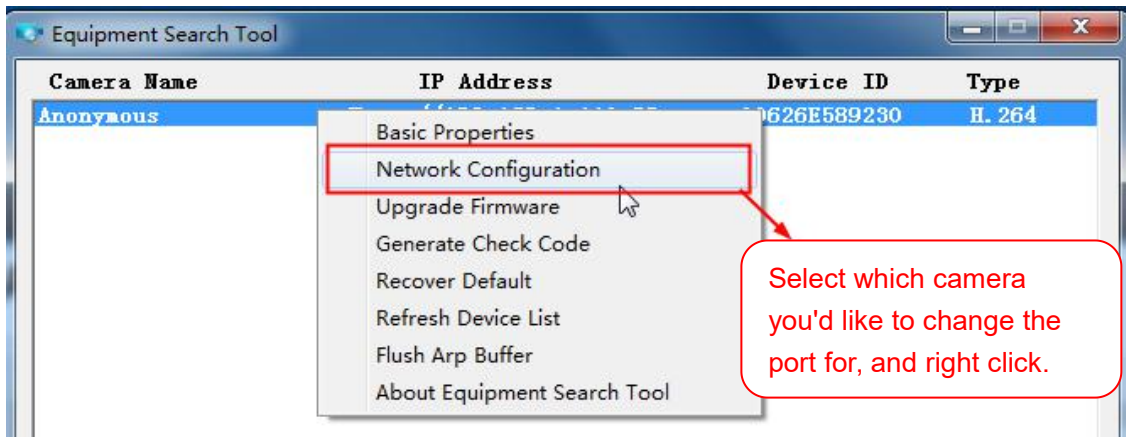

Step 2: Enter the username and password of the Administrator (default username is admin with a blank

password), and click **OK** to apply changes.

Step 3: Wait around 10 seconds, you'll see that the camera's LAN IP address has changed. In our example it was changed to 2000, so we see `http://192.168.1.110:2000` in Equipment Search Tool. Also, the LAN IP address is now fixed at a static IP address of `http://192.168.1.110:2000`. This IP address will not change even if the camera is powered off and back on, the camera will remain on this LAN IP address. This is very important that a static LAN IP address is set, or you may have problems later with remote access and seeing the camera remotely if the camera loses power and reconnects on a different LAN IP address. Make sure you set a static LAN IP address!



Camera Name	IP Address	Device ID	Type
Anonymous	Http://192.168.1.110:2000	00626E589230	H. 264

NOTE: If the camera cannot be accessed, please make sure the port forwarding is succeed.

HTTPS port: The default port is 443. You can use the url to access the camera: **[https:// IP + HTTPS port](https://IP+HTTPS+port)**

ONVIF Port: By default, the ONVIF port is set to 888. Also, they can be assigned with another port number between 1 and 65535 (except 0 and 65534). But make sure they can not be conflict with other existing ports.

4.3.4 Mail Settings

If you want the camera to send emails when motion has been detected, here Mail will need to be configured.

		5	Save	Refresh
Enable <input checked="" type="checkbox"/>				
SMTP Server		smtp.gmail.com Example:smtp.sample.com/cn/com.cn SMTP server address supports English, numbers and @ _ . -		
SMTP Port	1	25		
Transport Layer Security		STARTTLS G-Mail only supports TLS at Port 465 and STARTTLS at Port 587 or 25. Hotmail only supports STARTTLS at Port 587 or 25.		
Need Authentication		Yes		
SMTP Username	2	cuiyao93@gmail.com Example:someone@sample.com The maximum length of the user name is 63, support numbers, letters and symbols @ _ . \$ * -		
SMTP Password	 The maximum password length is 16, including numbers, letters and symbols ~ ! @ # * () _ { } : " < > ? ` - ; ' \ , . /		
Sender E-mail	3	cuiyao93@gmail.com	Test	6
First Receiver	4	yaoyao@163.com Example:someone@sample.com The maximum length of the receiver is 63, support numbers, letters and symbols @ _ . \$ * -		
Second Receiver				
Third Receiver				
Fourth Receiver				

1---- SMTP Server / Port / Transport Layer Security Enter SMTP server for sender. **SMTP** port is usually set as 25. Some SMTP servers have their own port, such as 587 or 465, and Transport Layer Security usually is None. If you use Gmail, Transport Layer Security must be set to TLS or STARTTLS and SMTP Port must be set to 465 or 25 or 587, which port you choose should be decided by which Transport Layer Security you select.

2---- SMTP Username / password ID account and password of the sender email address

3---- Sender E-mail Mailbox for sender must support SMTP

4---- Receiver Mailbox for receiver need not support SMTP, you can set 4 receivers

5---- **Save** Click **Save** to take effect

6---- **Test** Click **Test** to see if Mail has been successfully configured.

Click **Test** to see if Mail has been successfully configured.

The screenshot shows a web-based configuration interface for email settings. At the top right, there are 'Save' and 'Refresh' buttons. Below them is an 'Enable' checkbox which is checked. The main area is a table with the following fields:

SMTP Server	smtp.gmail.com Example: smtp.sample.com/cn/com.cn SMTP server address supports English, numbers and @ _ . -
SMTP Port	25
Transport Layer Security	STARTTLS G-Mail only supports TLS at Port 465 and STARTTLS at Port 587 or 25. Hotmail only supports STARTTLS at Port 587 or 25.
Need Authentication	Yes
SMTP Username	cuiyao93@gmail.com Example: someone@sample.com The maximum length of the user name is 63, support numbers, letters and symbols @ _ . \$ * -
SMTP Password The maximum password length is 16, including numbers, letters and symbols ~ ! @ # * () _ { } : " < > ? ` - ; ' \ , . /
Sender E-mail	cuiyao93@gmail.com A 'Test' button is located to the right of the input field. Below the input field, the word 'Success' is displayed in a red box, with a red arrow pointing to another red box containing the text 'Test result.'
First Receiver	yaoyao@163.com Example: someone@sample.com The maximum length of the receiver is 63, support numbers, letters and symbols @ _ . \$ * -
Second Receiver	
Third Receiver	
Fourth Receiver	

If the test success, you can see the **Success** behind the Test, at the same time the receivers will receive a test mail.

If the test fails with one of the following errors after clicking **Test**, **verify** that the information you entered is correct and again select **Test** .

1) Cannot connect to the server.

- 2) Network Error. Please try later.
- 3) Server Error.
- 4) Incorrect user or password.
- 5) The sender is denied by the server. Maybe the server need to authenticate the user, please check it and try again.
- 6) The receiver is denied by the server. Maybe because of the anti-spam privacy of the server.
- 7) The message is denied by the server. Maybe because of the anti-spam privacy of the server.
- 8) The server does not support the authentication mode used by the device.

4.3.5 FTP Settings

If you want to upload record files and images to your FTP server, you can set **FTP Settings**.

FTP Settings

FTP Server	<input style="width: 90%;" type="text" value="ftp://192.168.8.150"/> <small>Example:ftp://192.168.1.103/dir The maximum length of the address is 127, does not support the character & =</small>
Port	<input style="width: 90%;" type="text" value="21"/>
FTP Mode	<input style="width: 90%;" type="text" value="PORT"/>
Username	<input style="width: 90%;" type="text" value="User1"/> <small>The maximum length of the user name is 63, support numbers, letters and symbols _ @ \$ * - , . # !</small>
Password	<input style="width: 90%;" type="password" value="....."/> <small>The maximum password length is 63, including numbers, letters and symbols ~ ! @ # \$ % ^ * () _ + { } : " < > ? ` - ; ' \ , . /</small>
<input type="button" value="Test"/>	<input style="width: 90%;" type="text" value="Success"/>

Figure a

FTP Settings	
FTP Server	ftp://ftp.mgenseal.com Example:ftp://192.168.1.103/dir The maximum length of the address is 127, does not support the character & =
Port	21
FTP Mode	PORT
Username	User 1 The maximum length of the user name is 63, support numbers, letters and symbols _ @ \$ * - , . # !
Password The maximum password length is 63, including numbers, letters and symbols ~ ! @ # \$ % ^ * () _ + { } : " < > ? ` - ; ' \ , . /
Test	Success

Figure b

FTP server: If your FTP server is located on the LAN, you can set as Figure a.

If you have an FTP server which you can access on the internet, you can set as Figure b.

Port: Default is port 21. If changed, external FTP client program must change the server connection port accordingly.

FTP Mode: Here supports two modes: PORT and PASV.

Username / password: The FTP account and password.

Click **Save** to take effect.

Click **Test** to see if FTP has been successfully configured.

4.3.6 P2P

Access the IP camera by Smart Phone (Android or iOS operating system)

First of all, you need to open the P2P function of the IP camera at **Settings > Network > P2P**.

P2P	
UID	F4SHJLMGK6YK8O8J0G5JBZZZ
Enable P2P	<input checked="" type="checkbox"/>
P2P Port	31087

Search and install **Foscam app** on Google Play and app Store for for Android and iOS devices.

If you want to know more details of the iOS app or Android app, please refer to the HELP on the iOS app or Android APP.

NOTE:

If the QR code scanning is not successful, please input the UID on the bottom of the camera manually.

4.4 Video

This section allows you to configure video settings, on screen display, snapshot settings and so on.

4.4.1 Video Settings

The screenshot shows a web interface titled "Video Settings". At the top right, there are "Save" and "Refresh" buttons. The interface is divided into two sections: "Main stream video settings" and "Sub stream video settings". Each section contains a table of settings with dropdown menus.

Main stream video settings	
Stream Type	HD Mode
Resolution	1080P
Bit Rate	1M
Frame Rate	15
Key Frame Interval	30
Rate Control Mode	VBR

Sub stream video settings	
Stream Type	HD Mode
Resolution	720P
Bit Rate	512K
Frame Rate	11
Key Frame Interval	15
Rate Control Mode	VBR

Stream Type: There are four types to identify different streams you have set. If select the HD Mode, the clearer video will become, and it will take up more bandwidth; If select the Smooth Mode, the bandwidth is very narrow, and bit rate is large, that will lead to video can not play well. The Equilibrium Model is a value between HD Mode and Smooth Mode.

Resolution: The camera supports five types: 1080P, 720P, 960P, VGA (640*480), and QVGA (320*240). The higher the resolution is, the clearer video will become. But the code flux will become larger too, and it will take up more bandwidth.

Bit Rate: Generally speaking, the larger the bit rate is, the clearer video will become. But the bit rate configuration should combine well with the network bandwidth. When the bandwidth is very narrow, and bit rate is large, that will lead to video can not play well.

Frame Rate: Note that a larger frame size takes up more bandwidth. When the video format is 50Hz, the

maximum frame rate is 25 fps. When the video format is 60Hz, the maximum frame rate is 30 fps. You should lower frame rate when the bandwidth is limited. Normally, when the frame rate above 15, you can achieve fluently video.

Key Frame Interval: The time between last key frame and next key frame. The shorter the duration, the more likely you will get a better video quality, but at the cost of higher network bandwidth consumption.

Rate Control Mode: Select the Bit rate type to constant or variable. If select VBR, the camera will change the video bit rate according to the situation, but will not more than the maximum parameter "Bit Rate"; If select CBR, the Bit Rate is unchanged; If select LBR, the image quality will be low, you can select LBR when the the Network is not good enough.

4.4.2 On Screen Display

This page is used to add timestamp and device name on the video.



OSD	
<input type="button" value="Save"/> <input type="button" value="Refresh"/>	
Display Timestamp	Yes
Display Camera Name	Yes

Display Timestamp: There are two options, **Yes** or **NO**. Select **Yes** and you can see the system date on the video.

Display Camera Name: There are two options, **Yes** or **NO**. Select **Yes** and you can see the device name on the video.

4.4.3 Privacy Zone

This page is used to set some mask as privacy zone on the video.



Privacy Zone	
<input type="button" value="Save"/> <input type="button" value="Refresh"/>	
Allow Privacy Zone	Yes
<input type="button" value="Set Privacy Zone"/>	

Allow Privacy Zone: Allow On Screen Display Mask, there are two options, **Yes** or **NO**. Select **Yes** and draw a mask area on the video, the mask area will be black on the video.



Click **OK** button and return to the **Privacy Zone** page, click **Save** to take effect.
Back to the surveillance window, you can see the mask area as the following picture:



4.4.4 Snapshot Settings

On this page you can set the snapshot pictures' image quality and the storage path.

Snapshot Settings

Snap Quality	Medium
Pictures Save To	None

Enable timing to capture

Capture interval	2 (1-65535s)
------------------	--------------

🕒 Schedule

All	00	01	02	03	04	05	06	07	08	09	10	11	12	13	14	15	16	17	18	19	20	21	22	23
MON																								
TUE																								
WED																								
THU																								
FRI																								
SAT																								
SUN																								

Snapshot Settings

Manual snap Quality	Medium
Pictures Save To	None

Enable timing to capture

Capture interval	2 (1-65535s)
------------------	--------------

🕒 Schedule

All	00	01	02	03	04	05	06	07	08	09	10	11	12	13	14	15	16	17	18	19	20	21	22	23
MON																								
TUE																								
WED																								
THU																								
FRI																								
SAT																								
SUN																								

Manual Snap Quality: Low, Middle and High. The higher the quality, the picture will be clearer.

Pictures Save To: FTP or SD Card. If you have done FTP and Alarm settings, when alarming, the camera will snap pictures to the FTP automatically. If select SD Card as the save path, make sure the camera has inserted in the SD card.

Enable Timing to Capture

To enable capture interval, follow the steps below:

1. Select Enable timing to capture
2. Capture interval: The interval time between two captures.
3. Select the capture time

- Capture anytime

Click the black button up the MON, you will see all time range turn red. When something moving in the detection area at anytime, the camera will capture.

- Specify an capture schedule

Click the week day words, the corresponding column will be selected. For example, click TUE, the all column of TUE turns to red, that means during Tuesday whole day, the camera will capture.

- Press the left mouse and drag it on the time boxes, you can select the serial area,

4. Click **Save** button to take effect.

4.4.5 IR LED Schedule

You can set the period of time during which the infrared lamp is turned off. You can also turn off the infrared lamp on the video preview page at any time.

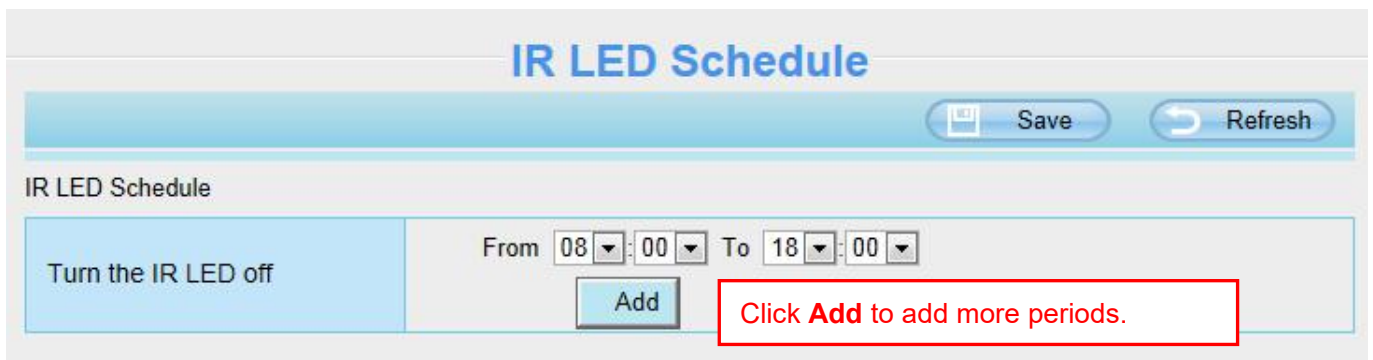

4.5 Detector

4.5.1 Motion Detection

IP camera supports **Motion Detection**, when the motion has been detected, it will send emails or upload images to FTP.

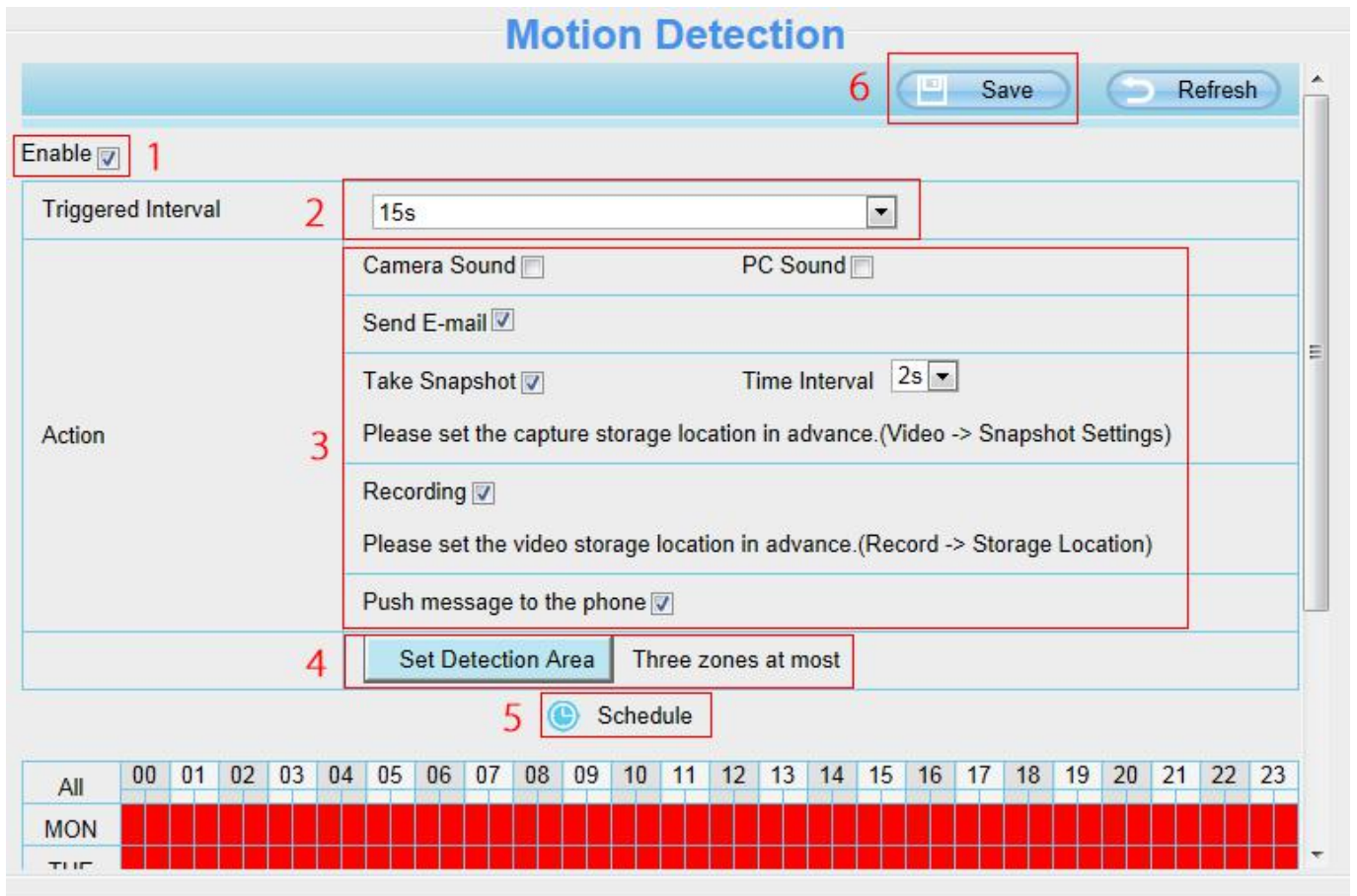

To enable motion detection, follow the steps below:

Step 01: Enable Motion detection

Step 02: Trigger interval--- The interval time between two motion detections. Select one interval time.

Step 03: Select the alarm indicator

When the motion has been detected, the Motion Alarm Status will turn to Detect Alarm.

Device Status	
Motion alarm status	Detect alarm
Sound alarm status	Disabled
Recording Status	Not Recording
SD Card Status	No SD card
SD Card Free Space	0KB
SD Card Total Space	0KB
NTP Status	Failed
DDNS Status	Failed
UPnP Status	Disabled
WiFi Status	Not connected
IR LED Status	Off

There are some alarm indicators:

A Camera Sound and PC Sound

If you select Camera Sound and the audio output device is connected to the IP camera, you will hear the alarm when the motion has been detected.

if you select PC Sound and the audio output device is connected to the PC, you will hear the alarm when the motion has been detected.

B Send E-mail

If you want to receive alarm emails when motion is detected, you must select Send E-mail and set Mail Settings first.

C Take Snapshot

If you select this checkbox, when the motion has been detected, the camera will snap the live view window as a still picture and load it to the FTP or SD card.

Make sure you have set the storage path in **Video > Snapshot Settings** panel.

Time interval: The interval time between two pictures.

D Recording

If you select this checkbox, when the motion has been detected, the camera will record automatically and store the record files.

Make sure you have set the Alarm record files storage path, please go to **Record > Storage location** page to verify this settings. The default alarm record time is 30s and pre-alarm record time is 5s, please go to **Record > Alarm Record** page and change the alarm time settings.

Step 04: Set detect area

Click **Set Detect Area** and it pop up a window, then you can draw the detection area. Click **OK** button after settings. When something moving in the detection area, the camera will alarm.

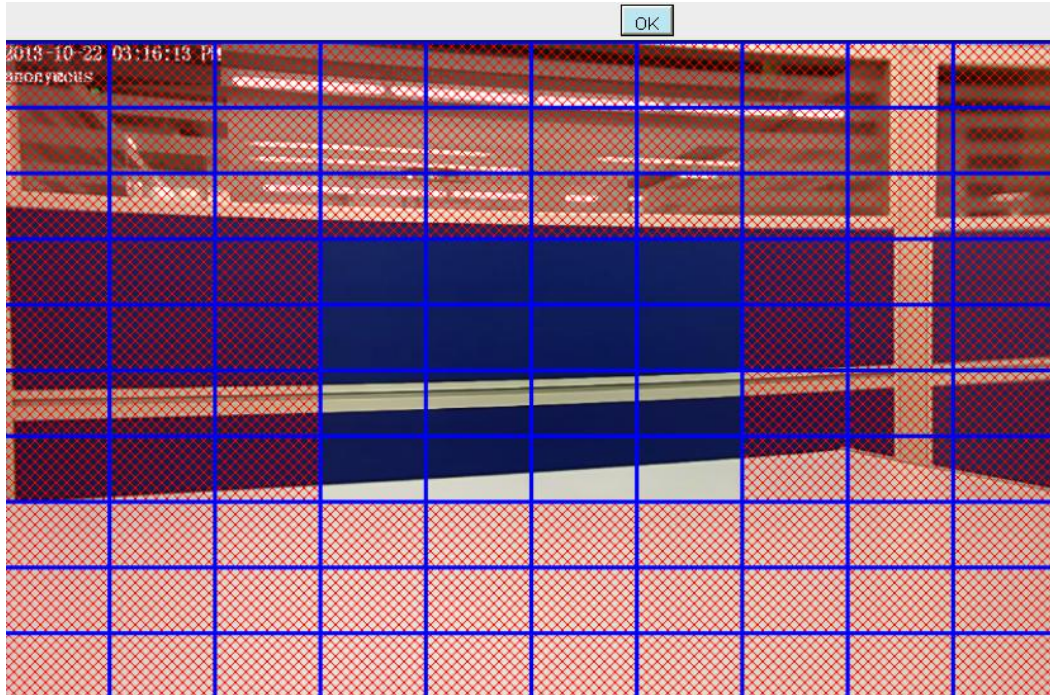

Step 05: Alarm Schedule

1. Alarm anytime when motion is detected

Click the black button up the MON, you will see all time range turn red. When something moving in the detection area at anytime, the camera will alarm.

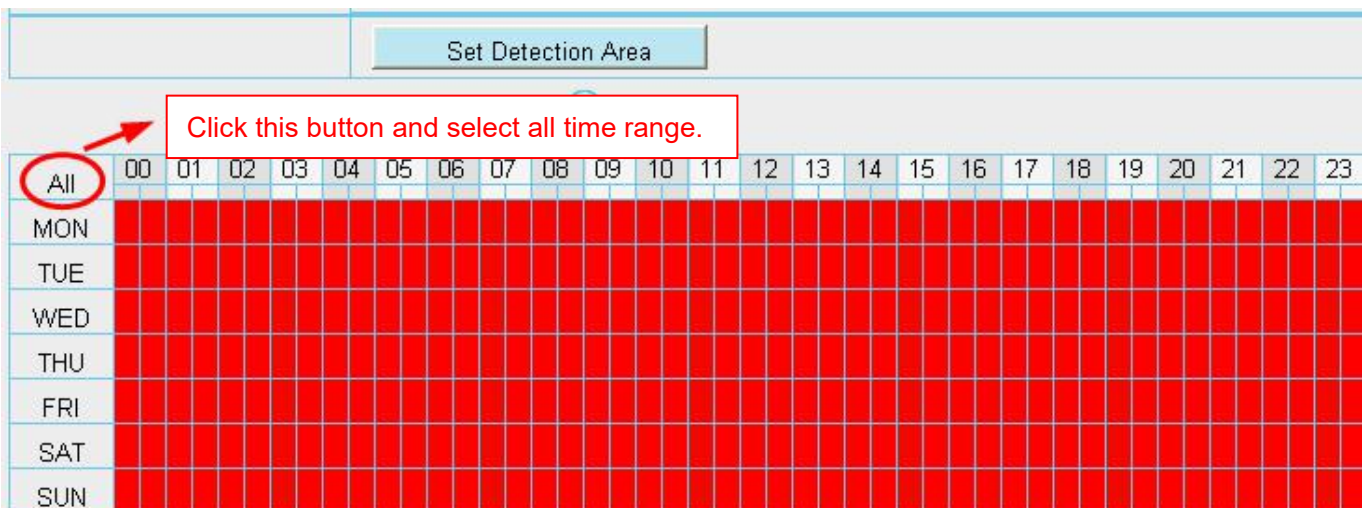

2. Specify an alarm schedule

Click the week day words, the corresponding column will be selected. For example, click **TUE**, the all column of TUE turns to red, that means during Tuesday whole day, when something moving in the detection area, the camera will alarm.

		Set Detection Area																							
		Schedule																							
		00	01	02	03	04	05	06	07	08	09	10	11	12	13	14	15	16	17	18	19	20	21	22	23
MON																									
TUE																									
WED																									
THU																									
FRI																									
SAT																									
SUN																									

3. Press the left mouse and drag it on the time boxes, you can select the serial area,

		Set Detection Area																							
		Schedule																							
		00	01	02	03	04	05	06	07	08	09	10	11	12	13	14	15	16	17	18	19	20	21	22	23
MON																									
TUE																									
WED																									
THU																									
FRI																									
SAT																									
SUN																									

Step 06: Click Save button to take effect.

When the motion has been detected during the detection time in the detection area, the camera will alarm and adopt the corresponding alarm indicators.

NOTE:

You must set the detection area and detection schedule, or else there is no alarm anywhere and anytime.

4.5.2 Sound Detection

Sound Detection

Save Refresh

Enable

Sensitivity	Lower
Triggered Interval	15s
Action	Camera Sound <input type="checkbox"/> PC Sound <input type="checkbox"/>
	Send E-mail <input checked="" type="checkbox"/>
	Take Snapshot <input checked="" type="checkbox"/> Time Interval 2s
	Please set the capture storage location in advance.(Video -> Snapshot Settings)
	Recording <input checked="" type="checkbox"/> Please set the video storage location in advance.(Record -> Storage Location)
Push message to the phone <input checked="" type="checkbox"/>	

Schedule

All	00	01	02	03	04	05	06	07	08	09	10	11	12	13	14	15	16	17	18	19	20	21	22	23
MON																								

On the **Sound Detection** page, Enable the Sound Detection, select the **Send E-mail** and **Take Snapshot** before you have configured the mail and FTP.

To enable

For how to enable **Sound Detection**, please refer to [4.5.1 Motion Detection](#).

It will always alarm when Sound Detection is triggered if the alarm output device is connected to the IP camera (audible alarm is issued a warning sound).

4.5.3 I/O Alarm

This IP camera provides a I/O alarm terminal block which is used to connect to external input / output device. The alarm device (door sensor, infrared sensor, smoke detectors, etc) send input command to the network camera, then the network camera send output command to the alarm output device (local audible alarm, lights alarm,etc.).

IO

Enable

Trigger level	Low
Triggered Interval	15s
Action	Camera Sound <input type="checkbox"/> PC Sound <input type="checkbox"/>
	Send E-mail <input checked="" type="checkbox"/>
	Take Snapshot <input checked="" type="checkbox"/> Time Interval <input type="text" value="2s"/>
	Please set the capture storage location in advance. (Video -> Snapshot Settings)
Recording <input checked="" type="checkbox"/>	Please set the video storage location in advance. (Record -> Storage Location)
Push message to the phone <input checked="" type="checkbox"/>	
	<input checked="" type="checkbox"/> IO Output <input type="button" value="Clear IO Alarm Output"/>

There is a Alarm In/Out lines in the FOSCAM camera tails, as shown in the following picture. Enable sound detection need this cable to connect to the alarm device (door sensor, infrared sensor, smoke detector, etc.).

Alarm In/Out lines has four ports:

- Port 1 indicates IO alarm input
- Port 2 indicates GND
- Port 3 and port 4 indicate IO alarm output



IO Output

If IO alarm is triggered and IO alarm output device will always alarm (audible alarm is issued a warning sound, lights alarm lights in flash etc.). Click **Clear IO alarm output**, the alarm output device will stop alarming. If IO alarm is triggered again after alarm interval, IO alarm output device will be restart.

NOTE: Motion detection / Sound Detection alarm can also be triggered IO alarm output.

4.6 Record

4.6.1 Storage Location

On this page you can change the manually recording storage path.

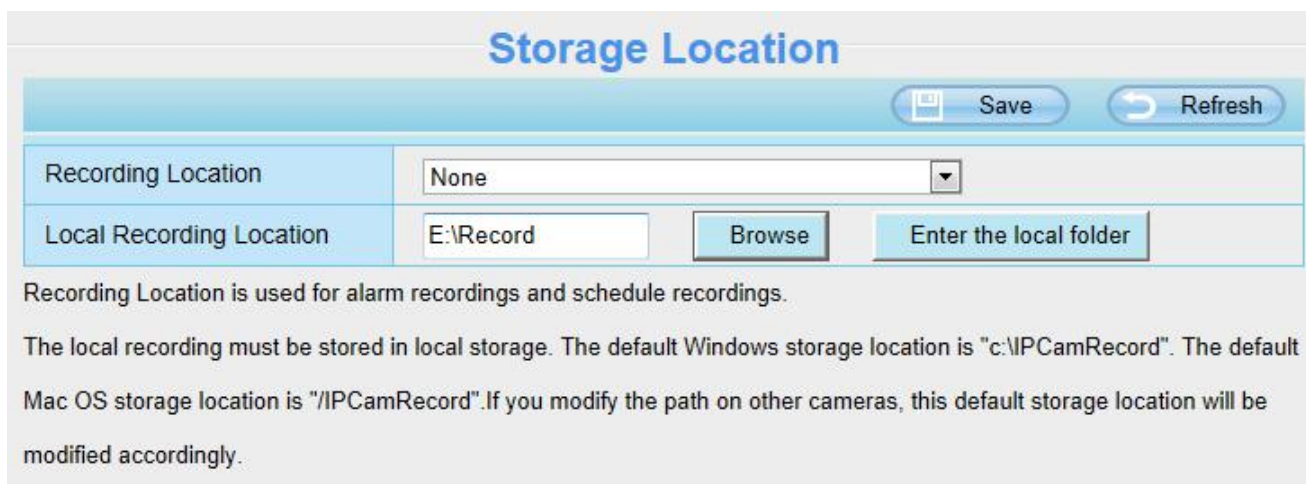

Recording Location: SD card or FTP. When the camera alarmed, it will store the alarm files to the SD card or FTP. If you select the SD card from the **Recording Location**, Make sure the camera has been inserted the SD card. On this page, you can see the available space of the SD card.

Local Recording Location: For Windows OS, the location recording path is c:\IPCamRecord, you can change another one. For MAC OS, the manual recording path is: /IPCamRecord.

4.6.2 Alarm Recording

This page you can change the Pre-record time and Alarm record time.

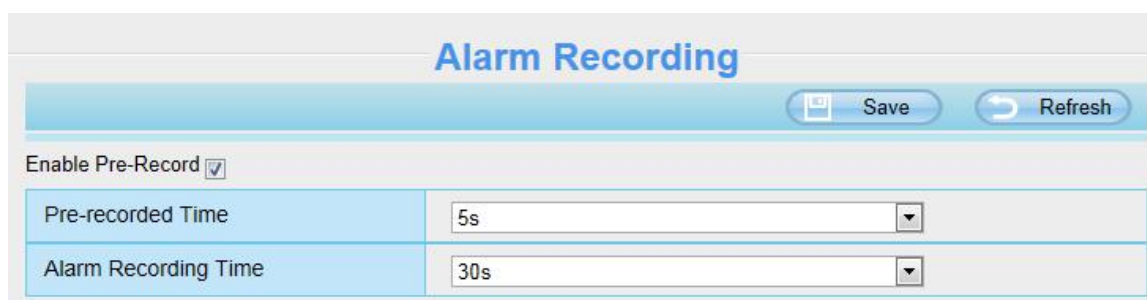

The default Pre-recorded time is 5s and the alarm record time is 30s, you can change another time, click **Save**

button to take effect.

4.6.3 Local Alarm Recording

On this page you can enable local alarm record, and select the local alarm record time.

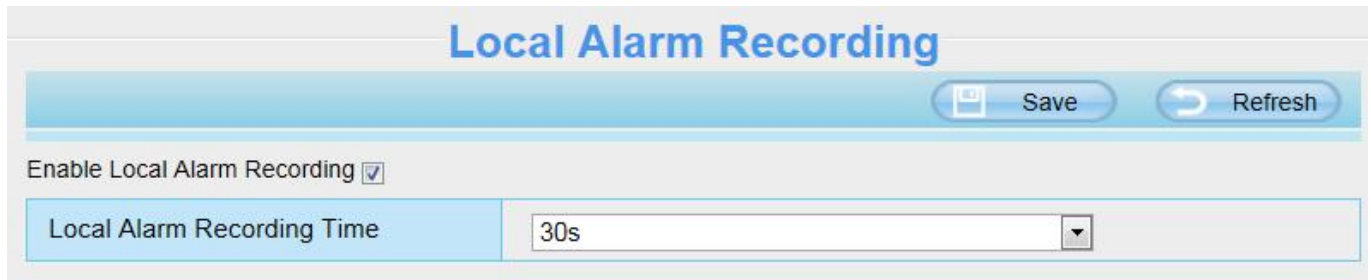

4.6.4 Scheduled Recording

On the page you can configure the schedule record.

When the parameter **Recording Location** is set **None** on the **Storage Location** page, the page **Schedule Recording** do not be setting.

When the parameter **Recording Location** is set **SD Card** on the **Storage Location** page, you can configure parameters as shown in follow figure.

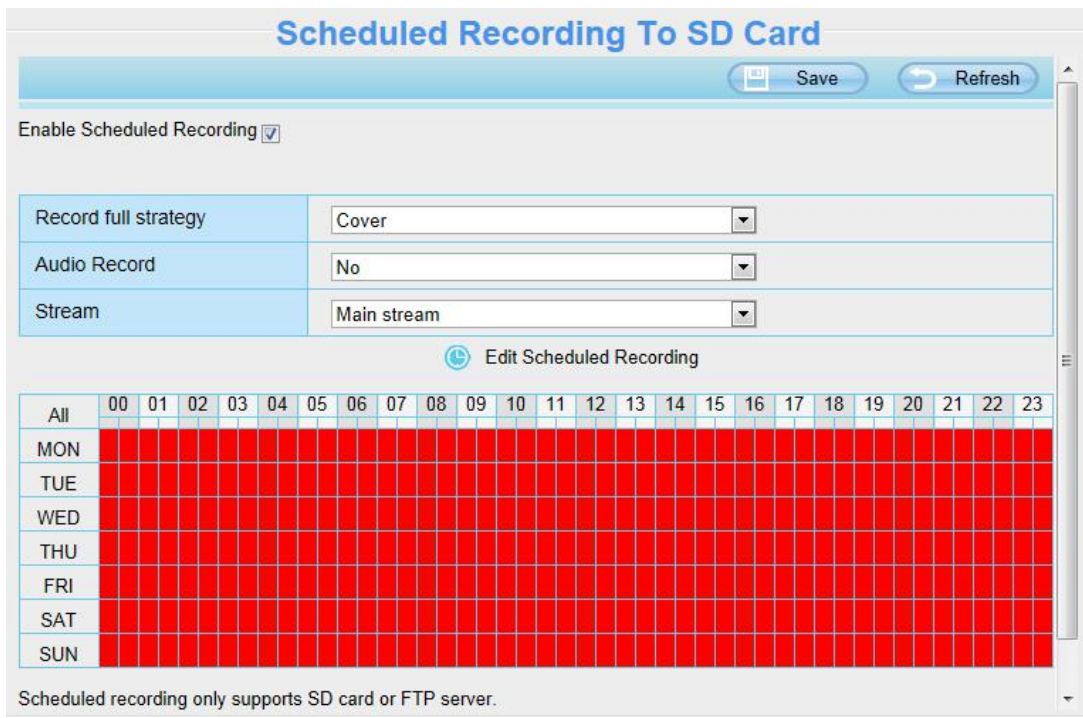

When the parameter **Recording Location** is set **FTP** on the **Storage Location** page, you can configure parameters as shown in follow figure.

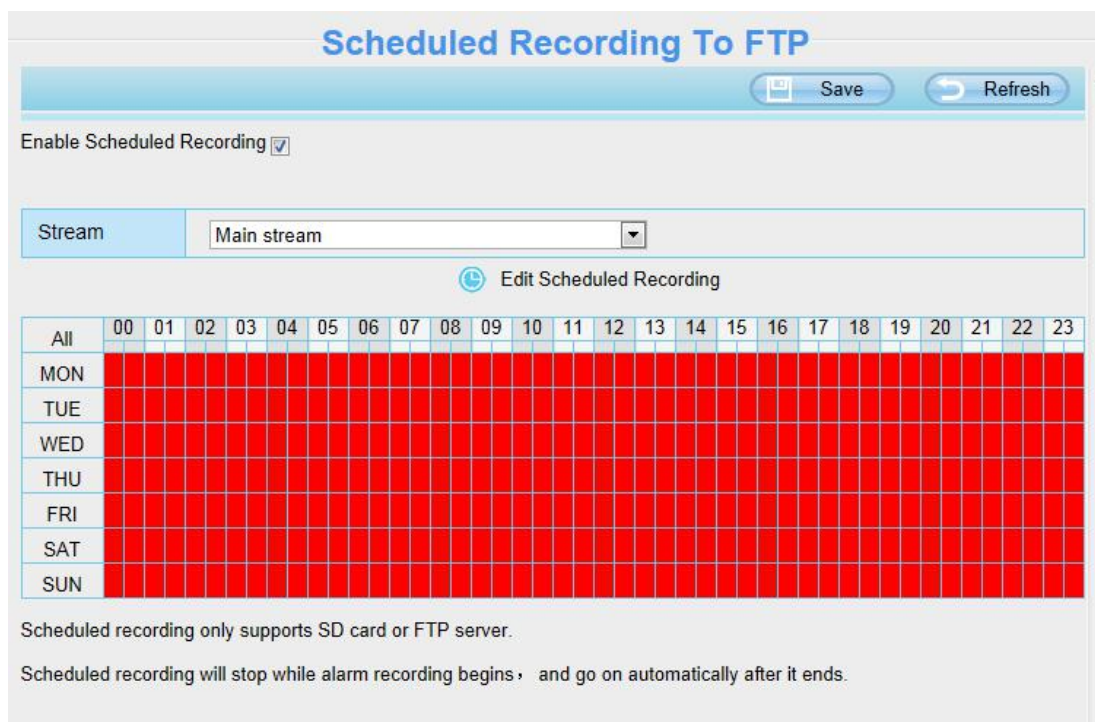

Click **Save** button to take effect.

4.6.5 SD Card Management

This camera supports Micro SD Card and the max size of SD card must be under 128G.

When you plug in the Micro SD card during the camera work process, please reboot the camera again, or else the SD Card may be cannot work well.

This page you can check the SD card information.

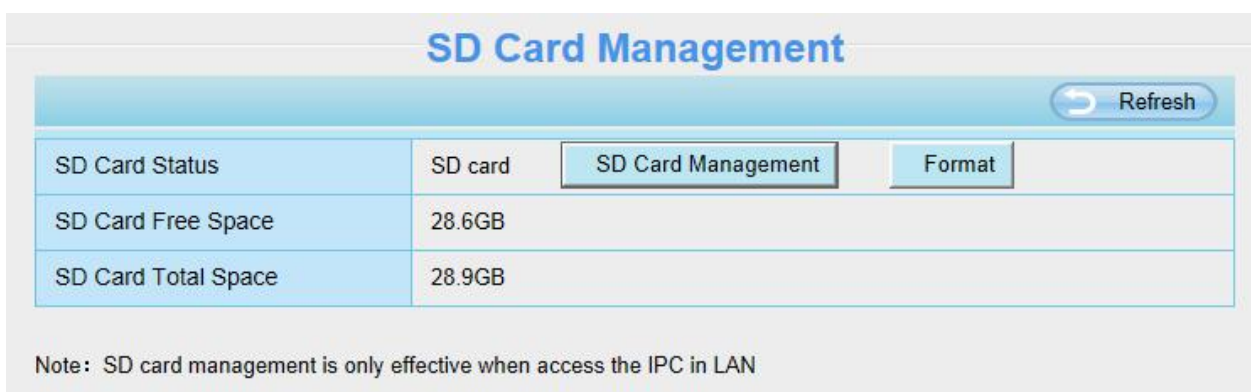

Go to the **Settings > Status > Device Status** page, you can see the SD card status.

The default storage path of alarm record files is SD card, when the available size of SD card is less than 256M, the old record files will be deleted automatically.

4.7 PTZ

This page will allow you to change the pan / tilt speed and do cruise tracks settings.

4.7.1 Pan / Tilt Speed

There are five PT speed types: very fast, fast, normal, slow and very slowly. Select the desired PTZ speed type and click save button.



Pan & Tilt Speed	
Pan & Tilt Speed	Normal
Auto focus	Off
Zoom & Focus Speed	Slow

Auto Focus: OFF is as default.

The change of PTZ or scenes will not (but focusing will) enable the Auto Focus when the Auto Focus button is OFF.

The change of PTZ and focusing will enable the Auto Focus when the Auto Focus button is ON.

4.7.2 Cruise Settings

This section explains how to add / delete / alter one cruise track.

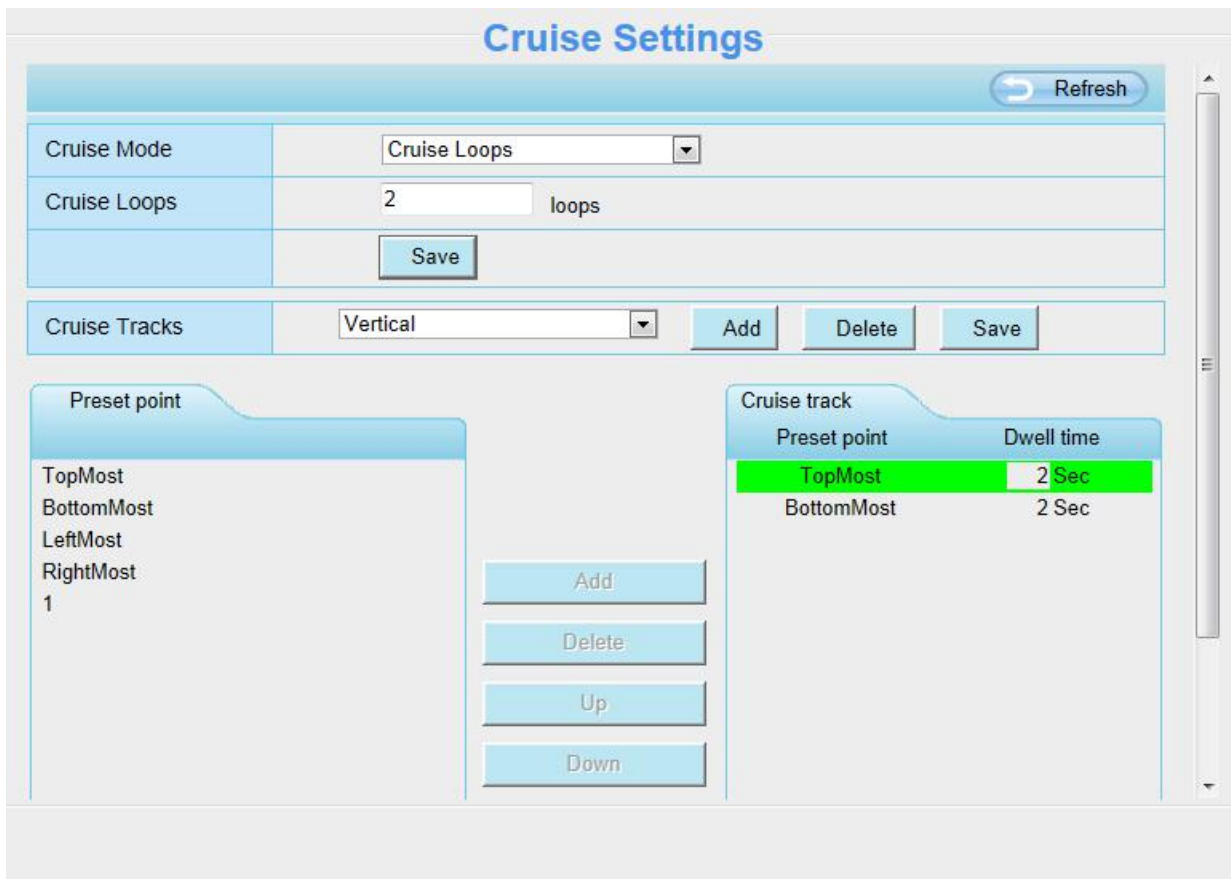

Cruise Mode: Include cruise loops and cruise time of one cruise track.

Cruise Loops: The cruise loops of one cruise track. For example, as the above figure, there are two loops on Vertical cruise tracks.

Cruise Time: The cruise time on one cruise track.

There are two default cruise tracks: Vertical and Horizontal.

Vertical: The camera will rotate from up to down

Horizontal: The camera will rotate from left to right.

Add: Add one cruise track.

Delete: Select one cruise track and delete it.

How to do add one cruise track?

Before adding one cruise track, please set all the presets of one cruise track on Live Video page. For example, as the figure below, five new presets is set.

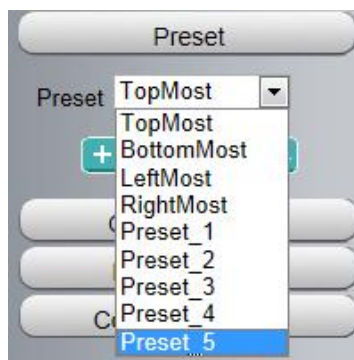

For how to set presets, please refer to [3.3 Surveillance Window](#) > Preset settings.

Then let us to set one cruise track as the following:

Firstly, click **Add** button and enter a descriptive name to identify the cruise track.

Secondly, on the lower left of the page, you can see all preset points you have added (preset_1 to preset_5). Then select the five preset points and add them to the cruise track on the right.

Note: Two or more preset points should be added to the cruise track, so the new cruise track will be added OK.

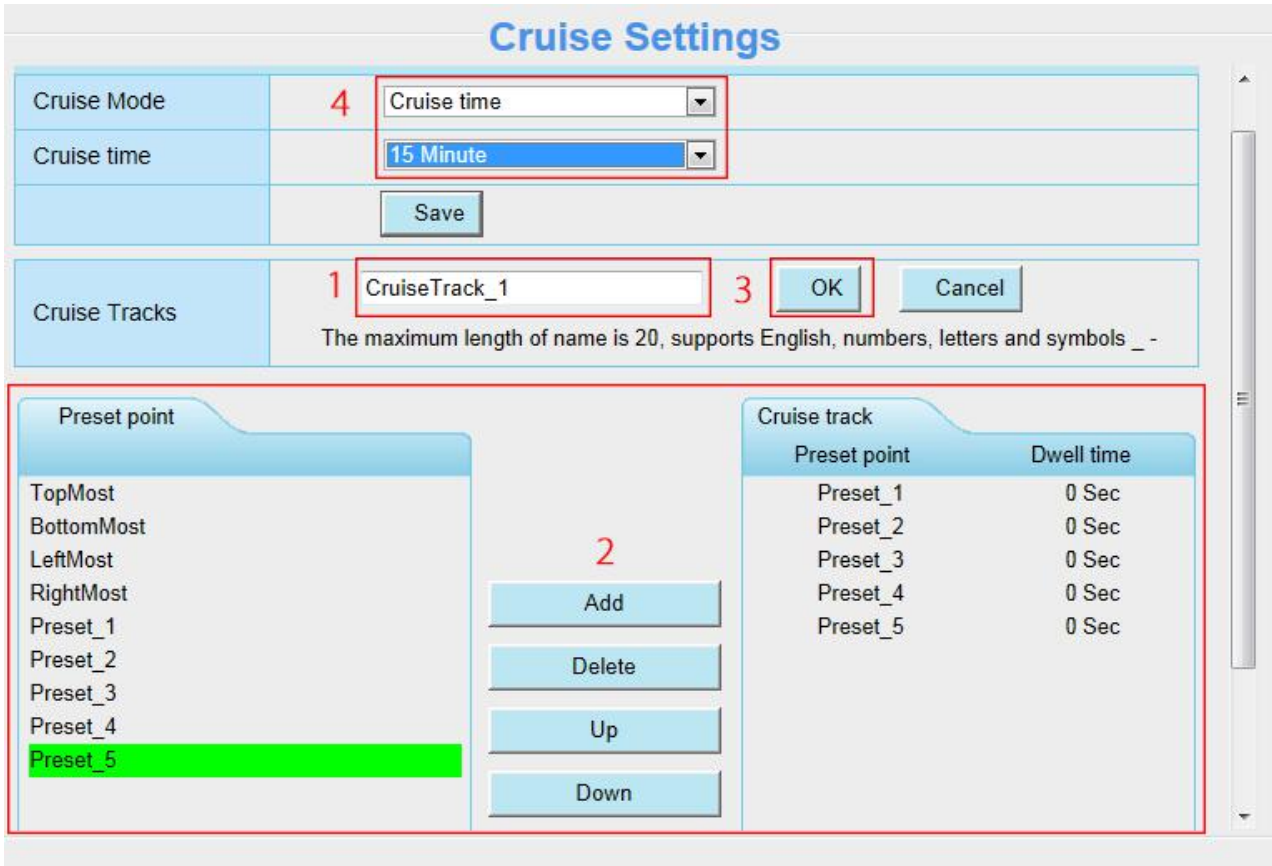

Fourthly, click **OK** and the CruiseTrack_1 will take effect.

At last, set the loops and the cruise time of the cruise track, For example, as the above figure, the cruise loop is 2, and the cruise time is 15 minutes.

You can add other cruise track as the same method.

There are other buttons between the Preset points and Cruise track, you can use these buttons to adjust the order of preset points or add / delete one preset points in one cruise track,

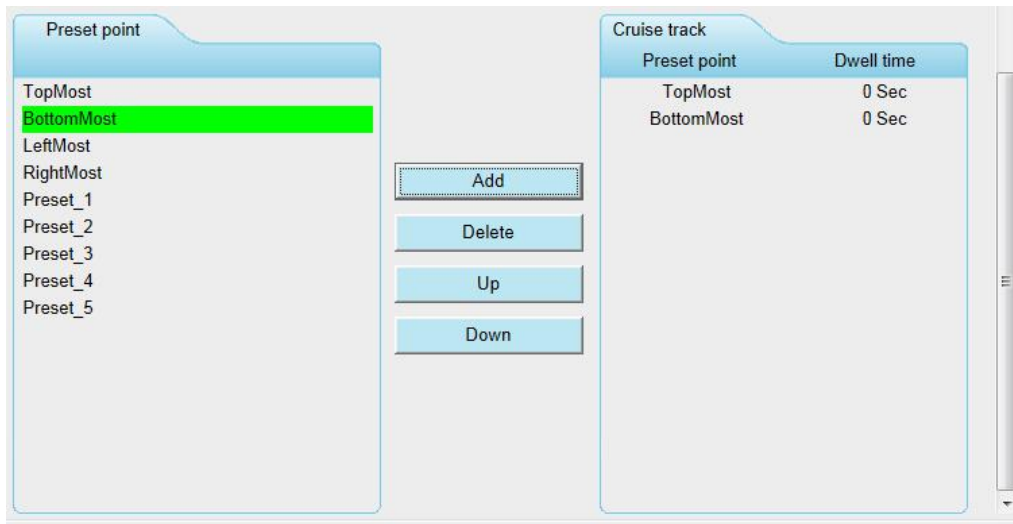

Add: Select one preset points and add it to the selected cruise track.

Delete: Select one preset points you have added to one cruise track, click **Delete**.

Move up / down: Select one cruise track, adjust the order of preset points in one cruise track.

Attention: Considering the life time and thermal issue of the motor, it's not recommend to do long-time cruise.

4.7.3 Start-Up Options

Here section will allow you to set the stop position after the camera reboots.

It supports three modes: Disable Start-Up, Go to Home Position and Go to Guard Position.

Disable Start-Up: When rebooting, the camera will not pan / tilt.

Go To Home Position: When rebooting, the camera will providing Video Management System to manage or monitor multi-cameras Pan / Tilt and stops at center.

Go To Guard Position: Select one preset position and save it. When rebooting, the camera will pan / tilt and stops at the preset position you have set.



4.7.4 Guard Position Settings

After setting the guard position, your camcorder will automatically return to the guard position within a predetermined time (manually setting) when it stops moving (manually or cruise). You could refer to the following method:

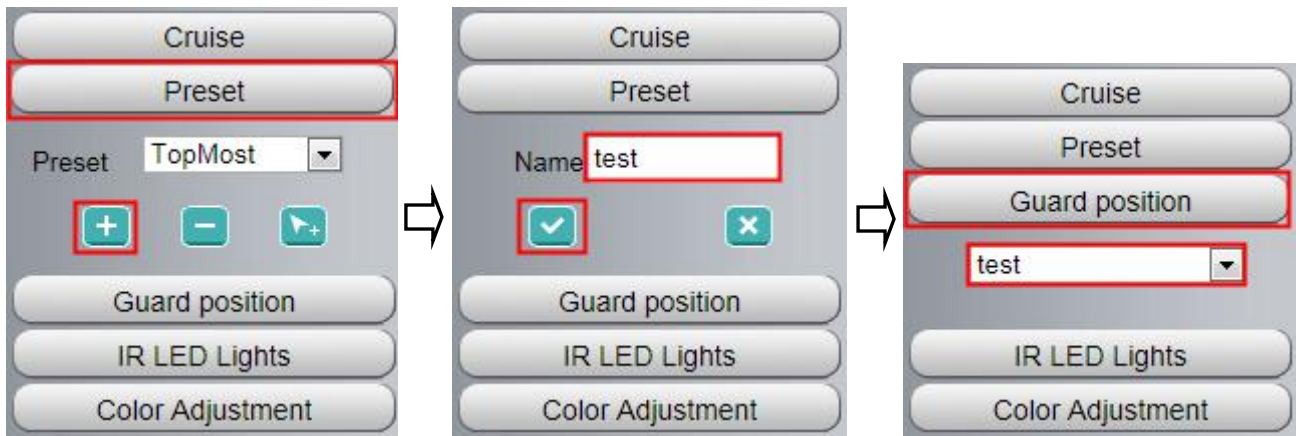

Then go to the **Settings > PTZ > Guard Position Settings** page to set time (min):



4.8 Firewall

This section explains how to control the access permission by checking the client PC's IP addresses. It is composed of the following columns: **Block access from these IP addresses** and **Only allow access from these IP addresses**.

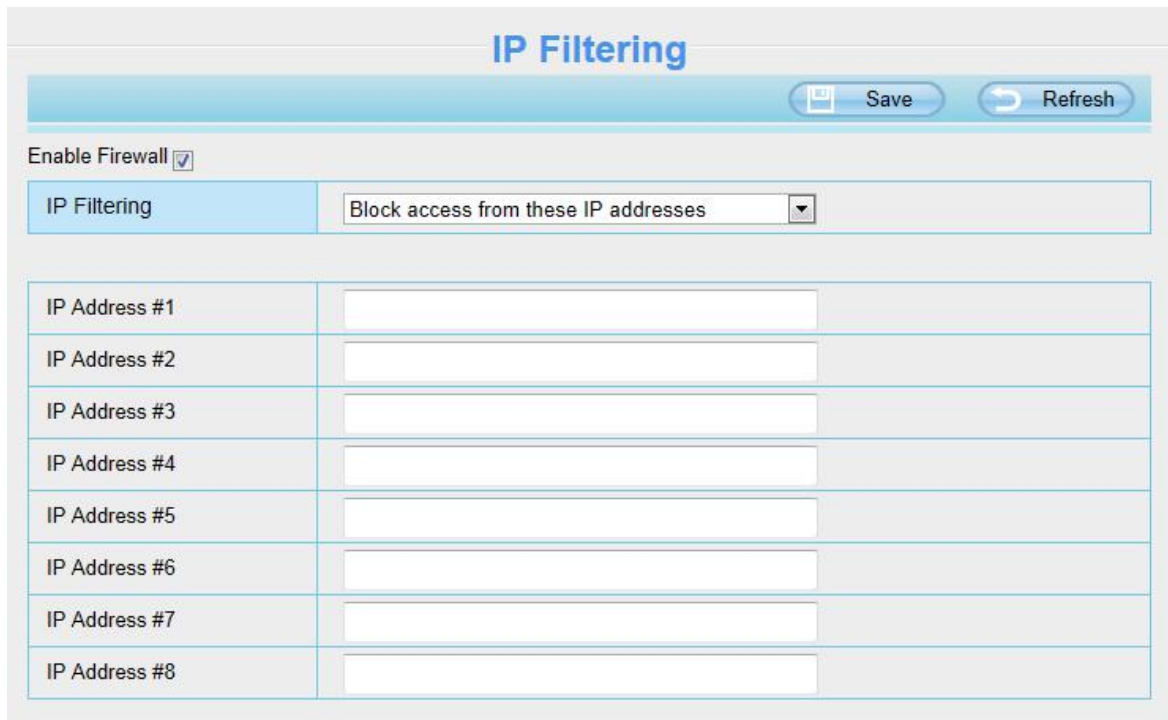

Enable firewall, If you select Only allow access from these IP addresses and fill in 8 IP addresses at most, only

those clients whose IP addresses listed in the **Only allow access from these IP addresses** can access the Network Camera. If you select **Block access from these IP addresses**, only those clients whose IP addresses are in the IP list cannot access the Network Camera.

Click **Save** to take effect.

4.9 System

In this panel, you can backup / restore your camera settings, upgrade the firmware to the latest version, restore the camera to default settings and reboot the device.

4.9.1 Back-up & Restore

Click **Backup** to save all the parameters you have set. These parameters will be stored in a bin file for future use.

Click **Browse** and select the parameters file you have stored, then click **Submit** to restore the restore the parameters.

Back-up & Restore

Backup is used to save your current settings. It is recommended to backup your configuration before modifying or upgrading firmware.

Settings can be restored by uploading the backup file.

Path:

Note:

1. All current settings will be overwritten when importing a configuration file. If a bad configuration file is uploaded the camera may not work.
2. Do not turn off the power during the config import, avoid to damage the Camera. The loading process takes about 50 seconds, the camera will reboot automatically.

4.9.2 System Upgrade

Click "Download the latest firmware", you will see the following screen. And click "save" to save the firmware on your computer locally.

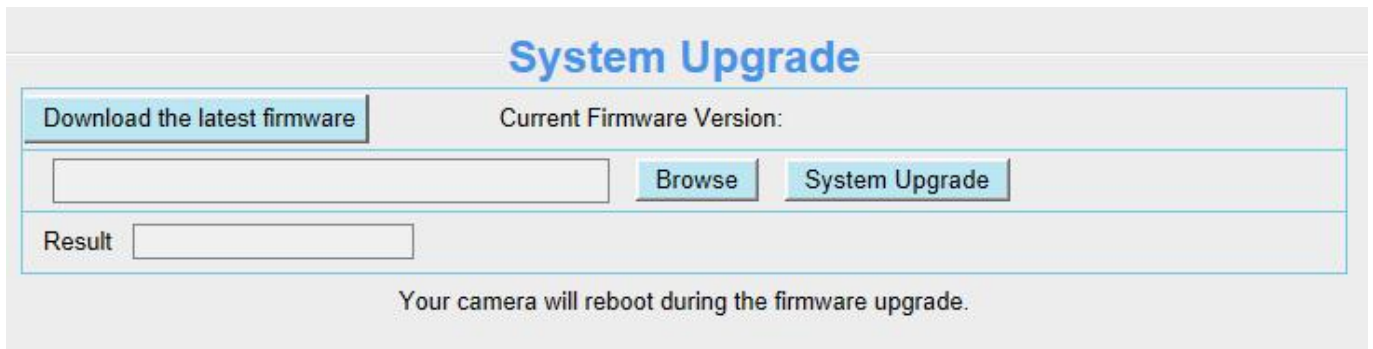

Your current firmware version will be displayed on your screen. You may go to the **Status > Device Information** page to check for the latest firmware versions available.

Click **Browse**, choose the correct bin file and then click **System upgrade**.

Don't shut down the power during upgrade. After upgrading, you can see the upgrade result.

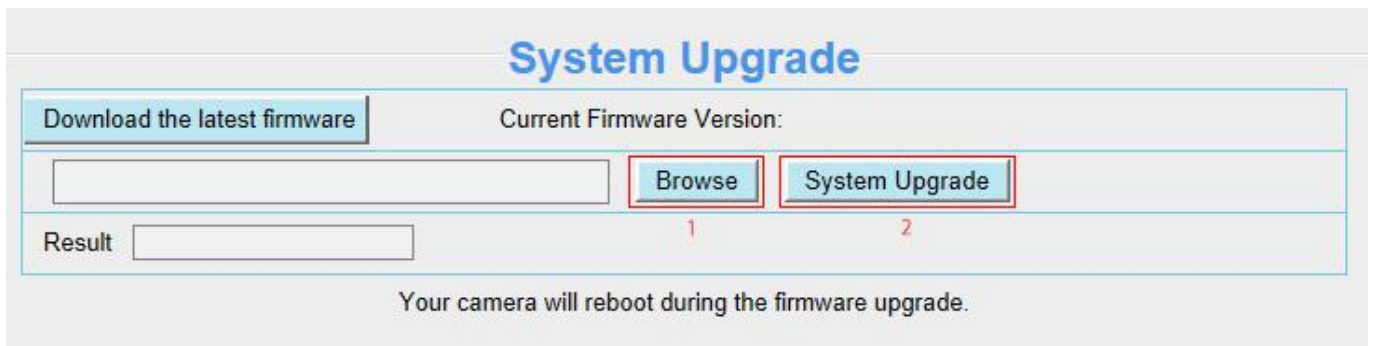

Upgrade Firmware by Equipment Search Tool

Double click the Equipment Search Tool shot icon , select the Camera IP that you want to upgrade the firmware. Then select Upgrade Firmware and enter the username and password, choose the firmware file, and upgrade.

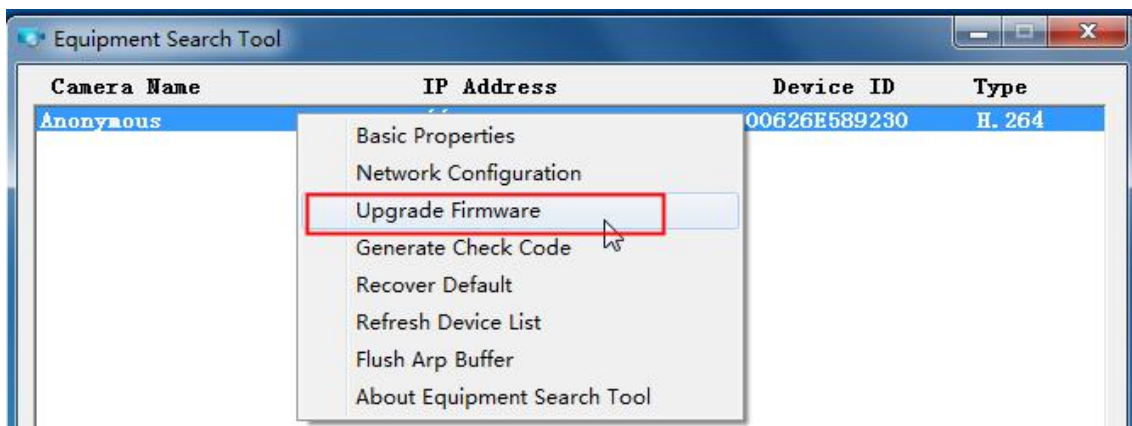

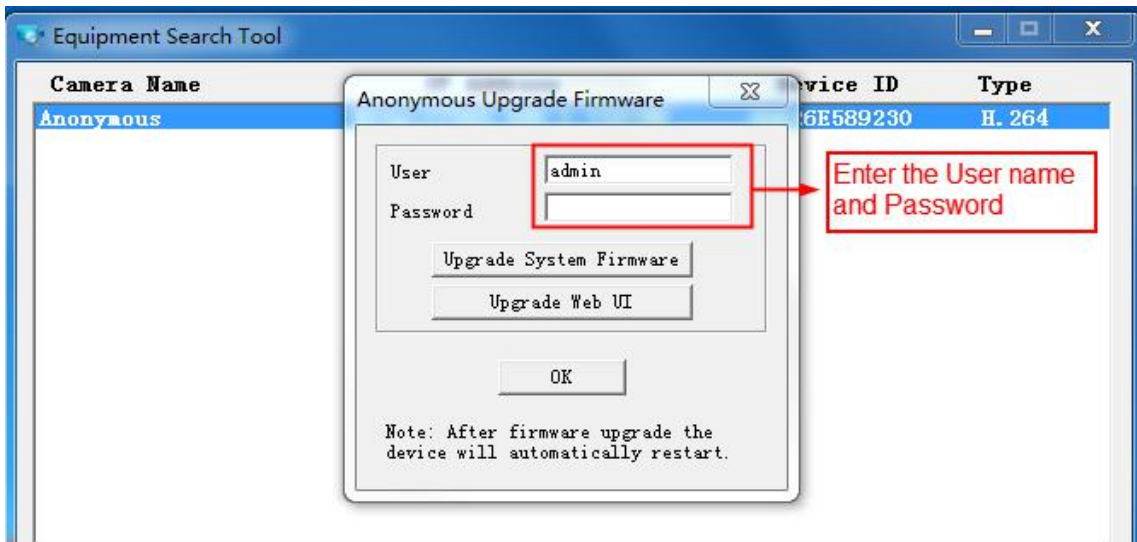

CAUTION: We recommend that you regularly update your camera to the latest available software and firmware versions to help ensure the best experience for your camera.

NOTE:

- 1) Please ensure you have download the correct firmware package for your camera before upgrading. Read the upgrade documentation (readme.txt file) in the upgrade package before you upgrade.
- 2) Upon downloading the firmware check the sizes of the .bin files. They must match the size in the readme.txt file. If not, please download the firmware again until the sizes are the same. Your camera will not function correctly if a corrupt .bin file is used.
- 3) Never shut down the power of the camera during upgrade until the IP camera restart and get connected.
- 4) After upgrade successfully, please uninstall the old plugin and re-install it, then reset the camera to the default factory settings before using the camera.

4.9.3 Patch Installation

Click **Browse** to select the correct patch file, and then click **Install Patch** to install the patch. Do not turn off the power during it installing. After installing is complete, you will receive a system prompt.

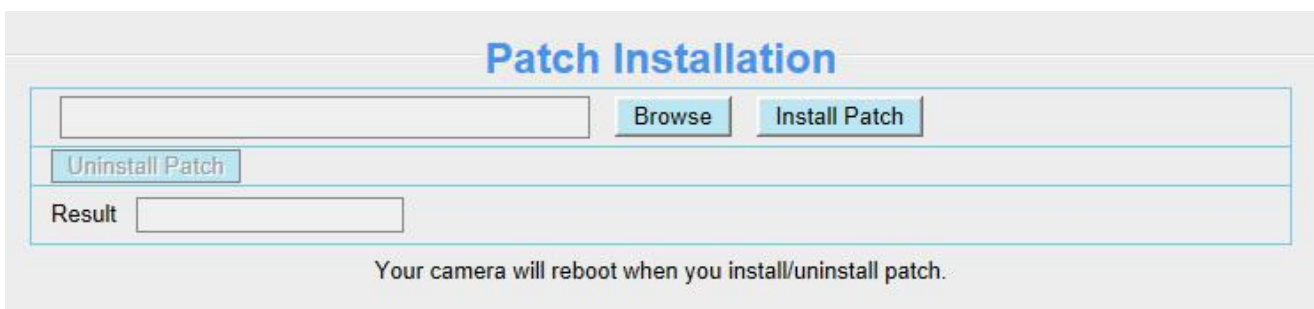

4.9.4 Factory Reset

Click All reset and all parameters will return to factory settings if selected. This is similar to press the Reset button on the bottom of the camera.

Factory Reset

Factory Reset

Click this button to reset the camera to factory default.

4.9.5 Reboot

Click Reboot System to reboot the camera. This is similar to unplugging the power to the camera.

Reboot

Reboot

Click this button to reboot your camera.

5 Playback

On this page you can view the record files stored in the SD card.

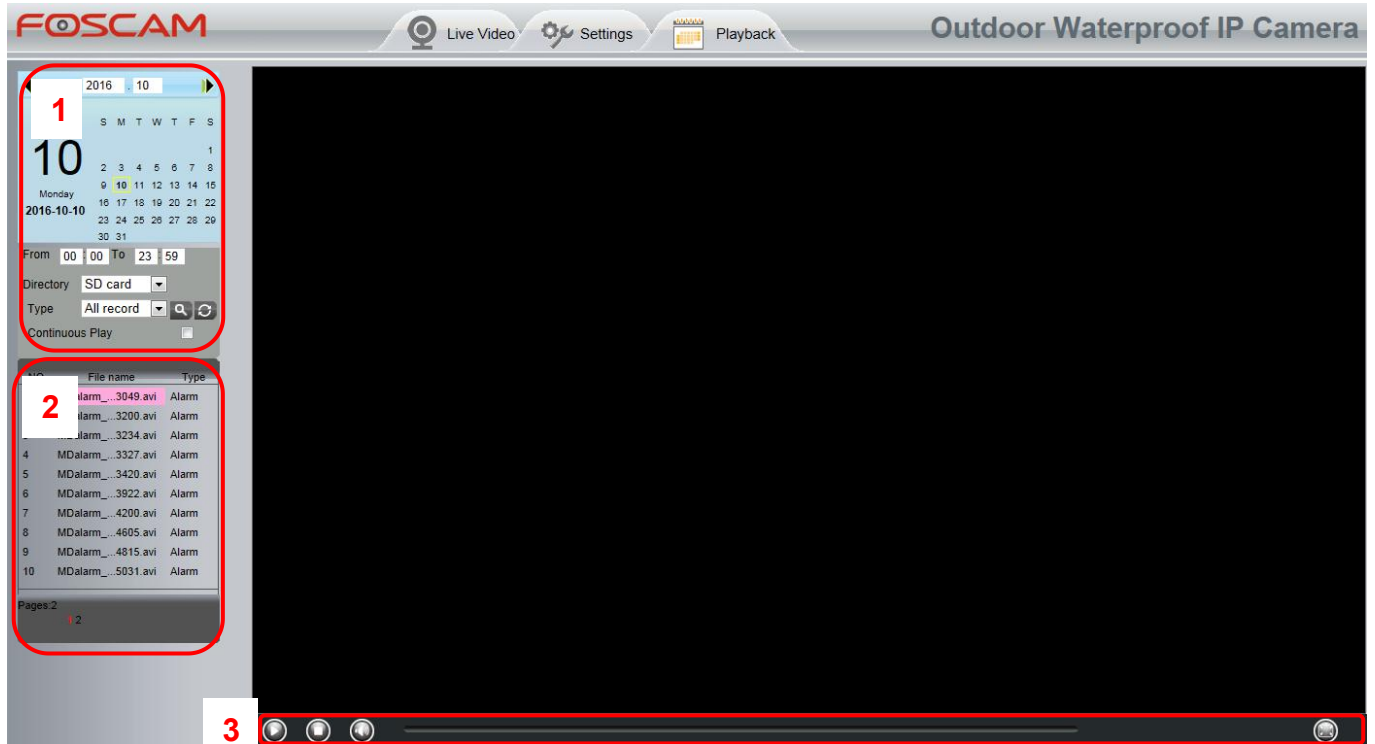

Section 1 Define the Record files time and Type

Select the time on the time & date manually.



Directory : The storage path of record files

Type : Here supports three types: all records, alarm recording, and Scheduled recording.

: Click this button to search all record files satisfy the conditions you selected.

Continuous Play: Select the checkbox to play continuously all the record files.

Section 2 Search record files

On this panel you can see all record files satisfy the conditions you set.

Section 3 Play / Stop / Audio / Full Screen Buttons

Please select one record file before use these buttons.



Click this button to play the record files



Click this button to stop the record files



Open / stop audio



Click this button to make full screen, and double click left mouse to exit full screen.

6 Appendix

6.1 Frequently Asked Questions

NOTE: Any questions you would meet, please check Network connections firstly. Check the working status revealed by the indicators on the network server, hub, and exchange. If abnormal, check the network connections.

6.1.1 Equipment search tool cannot find the camera.

After power on camera and connect it to router by Ethernet cable, open Equipment Search Tool it cannot find any camera IP address. Shows a blank window like below.

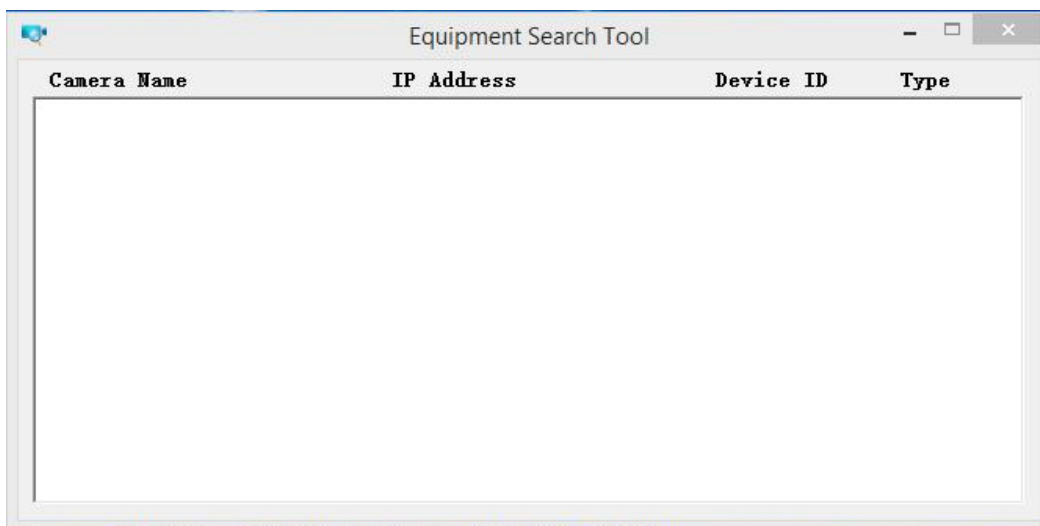

This is usually because camera doesn't get an IP in same network segment as the computer. Please follow below steps to fix the problem.

1. Make sure both camera and computer are connected to same router.
2. Make sure camera's connected to router properly and camera status is normal.
For indoor pan/tilt cameras, when powered on you will see a red power light and camera will pan/tilt. And on LAN port you'll see a blinking orange light and a solid green light.
3. Reset camera to have a check. Just keep pressing rest button on camera with power on for about 30 seconds till it reboot. Reset button is usually on back/bottom of camera, or on the end cords.
4. Try another Ethernet cable or hook into another LAN port on router.
5. Make sure the router DHCP server is enabled and there is no Mac address filter.
Check router's DHCP list as well, to see if you can find camera's IP address there.
If yes, please try to log-in the camera directly by manually input the IP address and port (default http port: for SD camera is 80, for HD camera is 88) of camera into address bar of web browser.
6. Please turn off any virtual machine or multiple connection (use only wired or wireless connection) that is running on computer.
7. At latest make sure there's no firewall is blocking Equipment Search Tool or other search tool conflicts with it.

6.1.2 Install plugin for Internet Explore

Suggest use IE browser to log in the camera and install the plugin for the first time, then you can use it on other browser as well. Just remember to allow the plugin to run. See below for steps to install plugin via IE browser.

Step 1: User IE browser to log in the camera for the first time, it will prompt to ask your install the plugin on the bottom of IE browser.

Step 2: Click **Install** to continue the installation of the .exe plugin.

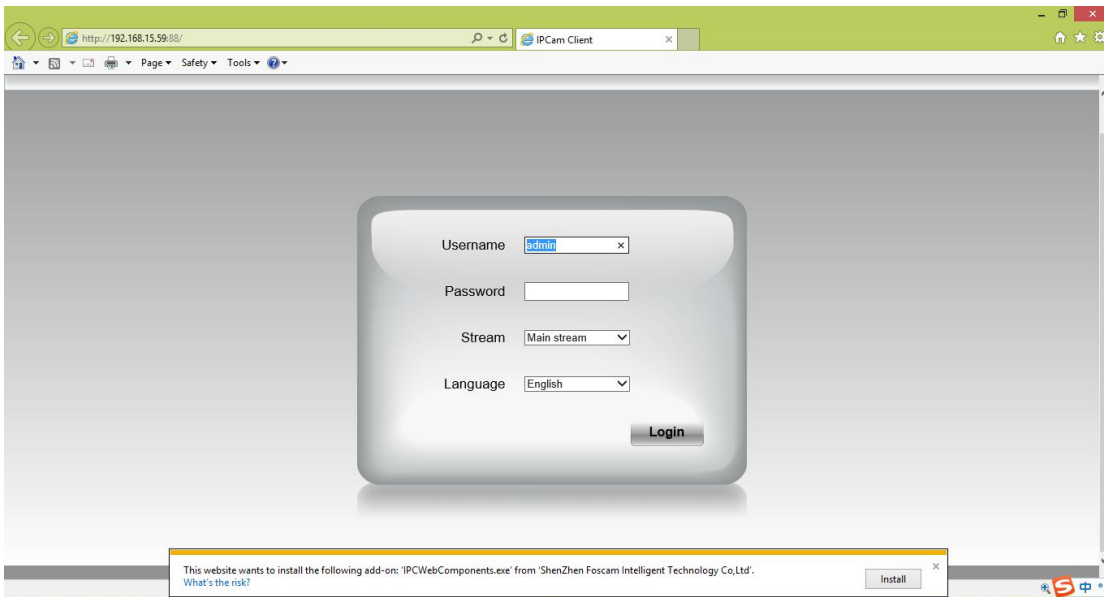

Step 3: Follow the Setup Wizard to finished installing the plugin

Note: When starting to install the plug-in, it will force to close the IE browser. Please click **Yes** to close the IE browser firstly.

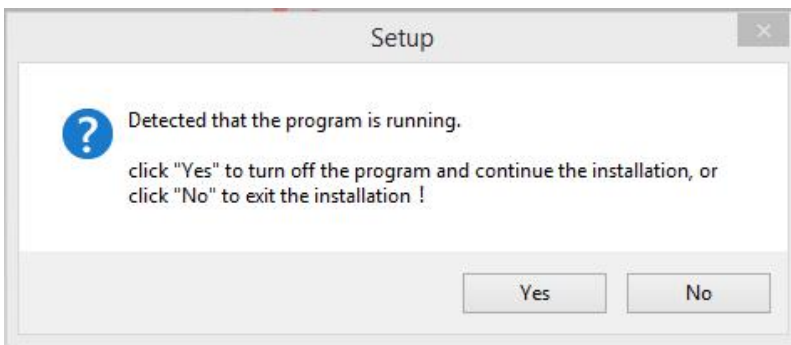

And click **Next** to follow the setup wizard.

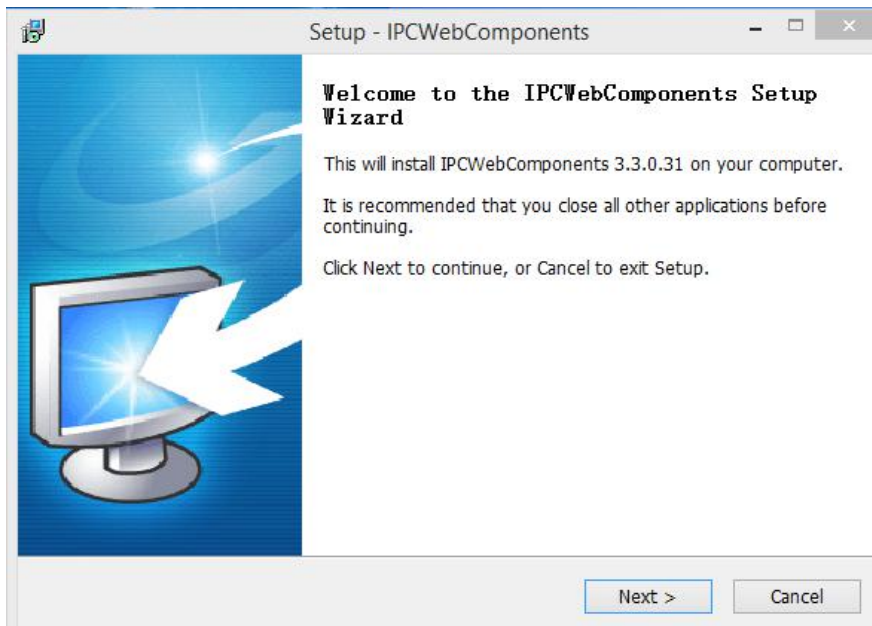

Step 4: Click **Finish** and reboot IE browser to log in the camera.

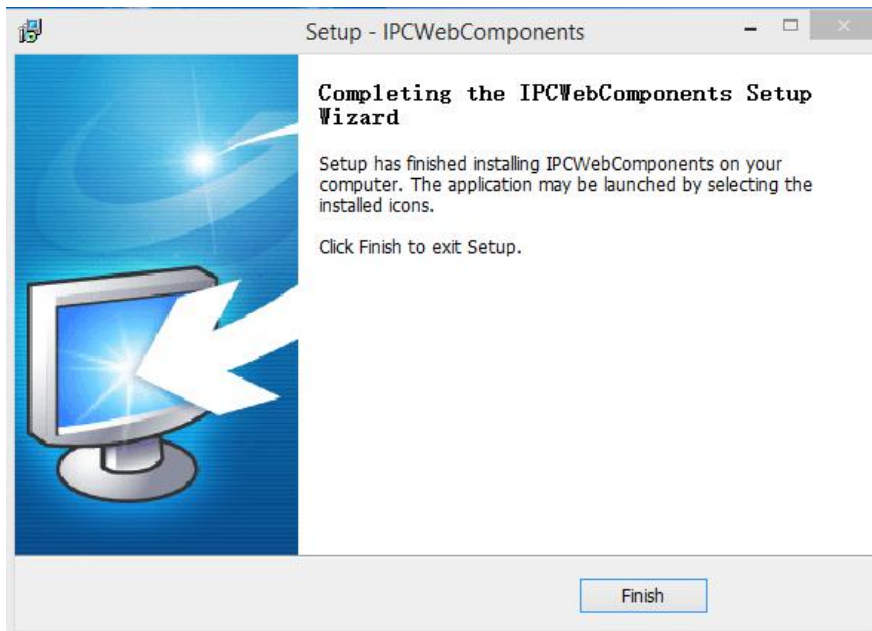

Note, for Safari on MAC OSX it'll show a link "Plugins are not found, click me to download" just above login windows of the camera. Please click it to download plugin and follow wizard to install. See this link for help if after installed plugin but still cannot login camera:

<http://www.foscam.com/faqs/view.html?id=14>

6.1.3 Unable to connect to router wirelessly

After setup wireless configuration, and input the wireless password correctly, save the settings. Normally, after you disconnect the Ethernet cable, wait for few minutes camera will show up again in Equipment Search Tool (or show up in router's DHCP client list/LAN list) with a new IP address. That indicates your camera's connected wirelessly.

If not, please follow below steps to help camera connect wirelessly.

Step1: Please make sure wireless signal is strong enough to connect with.

- (1) Make sure the camera antenna is fixed well;
- (2) Best to keep the distance between the camera and router in 2~3 meters while setup;
- (3) There's no interference or obstacles from house appliance or walls;

Step2: Please check if the frequency band of the wireless signal is 2.4GHz.

Our cameras only support connecting to 2.4GHz frequency wireless band. If your wireless router is dual band, that supports two frequency band 2.4GHz and 5GHz.

Please set the 2.4GHz and 5GHz with different SSIDs, and make sure configure camera to connect with the 2.4GHz SSID.

Step3: Please check if your wireless password contains special characters.

Remove special character in SSID and wireless password to have a try.

Step 4: Reboot camera and router to have a check.

If above are all confirmed, power off and on the camera and router may help camera to connect.

Step 5: Please log-in the router and check if the MAC filter feature is enabled.

Camera has wired and wireless MAC, they are different. If your router has wireless MAC filtering turned on, it'll block camera to connect. Please turn it off, or add camera's MACs in the allow list.

Step 6: Please change the wireless channel, and the wireless encryption of router to have a try.

Change channel helps reduce influence from nearby WiFi networks, you can try 3,6,or 11 for example. As for encryption, suggest use WPA2/PSK AES.

Step7: At last reset camera to default, and please try re-configure the wireless settings again.

6.1.4 Forgot camera's user name and password

Camera can be hard reset to default settings, when you forgot camera's login user name and password. Below are the steps:

- (1) Keep power on camera;
- (2) Press and hold reset button of camera for 30 second, till it reboots. Reset button is on bottom, or back, or end cords of the camera.
- (3) Once reset, camera will be restored to default settings. And default username is admin, no password (leave password blank).

6.1.5 How to setup alarm recording to SD card

For the cameras that support Mirco SD card, we can save alarm recording on SD card and below are the steps to set it up:

Step 1: Setup the Motion Detection Settings

Please go to **Settings > Alarm > Motion Detection** menu.

- (1) Click **Enable**.
- (2) Choose **Recording** for the alarm action.
- (3) Set the Detection Area
- (4) Set a Schedule.
- (5) Click **Save** to save the settings.

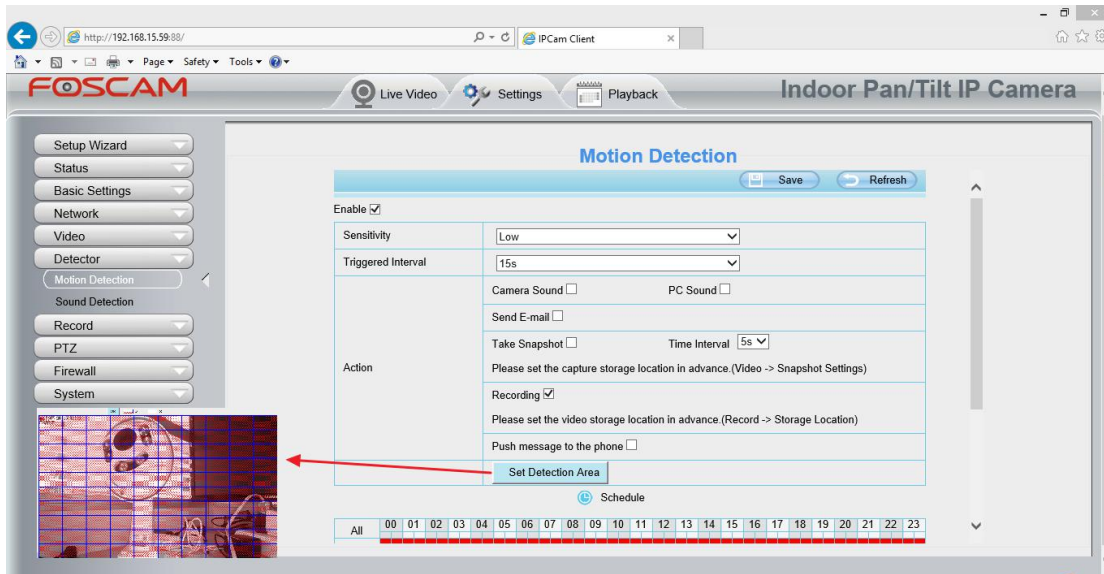

Note:

- 1) Please DO NOT forget to set the alarm schedule, the alarm schedule is red.
- 2) Please make sure your camera time is correct.
- 3) Please DO NOT forget to set the alarm area, the detected area is covered by the red grids. Or for some models you can setup 3 detection zones in total.

Step 2: Setup the Storage Location

Go to **Settings > Record > Storage Location**, and set the “Recording Location” to “SD card and click **Save**.

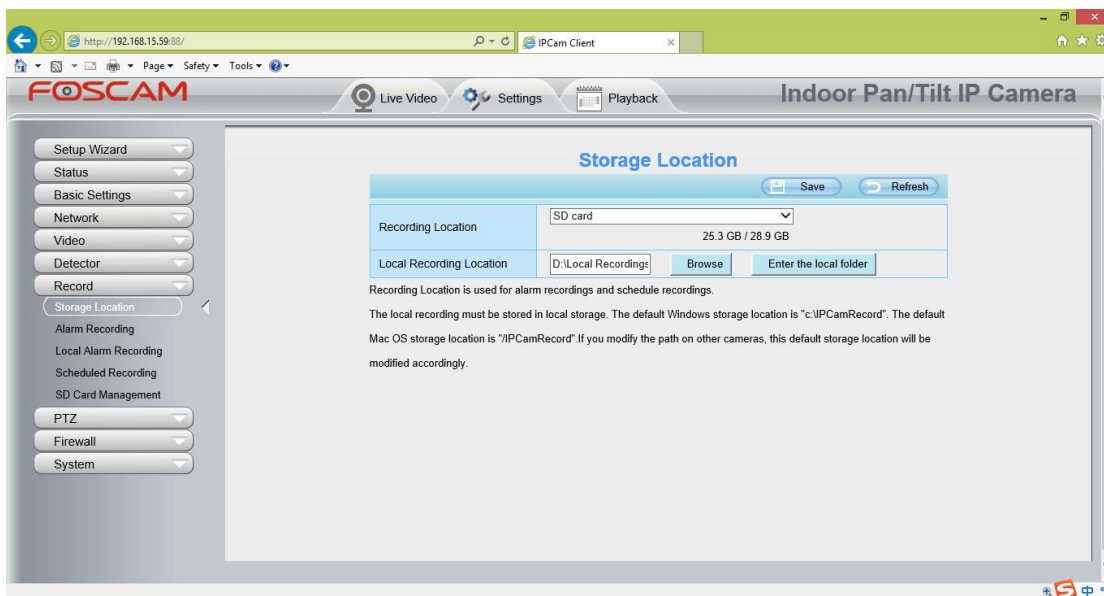

Note:

SD card needs format correctly so it'll be identified by camera, and has enough space for saving the recordings. It's suggested to use FAT32 for 4G~128G SD card and exFAT for 128G and above SD card.

6.1.6 How to setup alarm Emails

Setup alarm Emails, when camera detects a motion it'll send Email with snapshot to inform about the motion alarm. Steps as below.

Step 1: Setup Mail Settings

Before you set, please make sure that your email for sender enabled SMTP. And get your Email SMTP server, SMTP port, TLS information ready.

Please go to **Settings > Network > Mail Settings** menu to setup your email firstly.

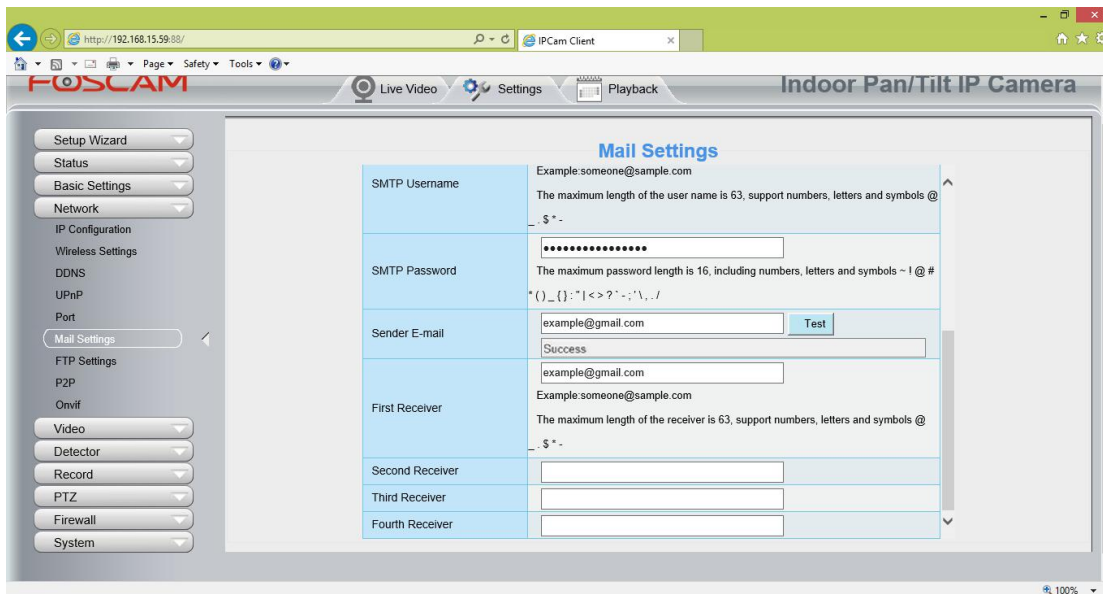
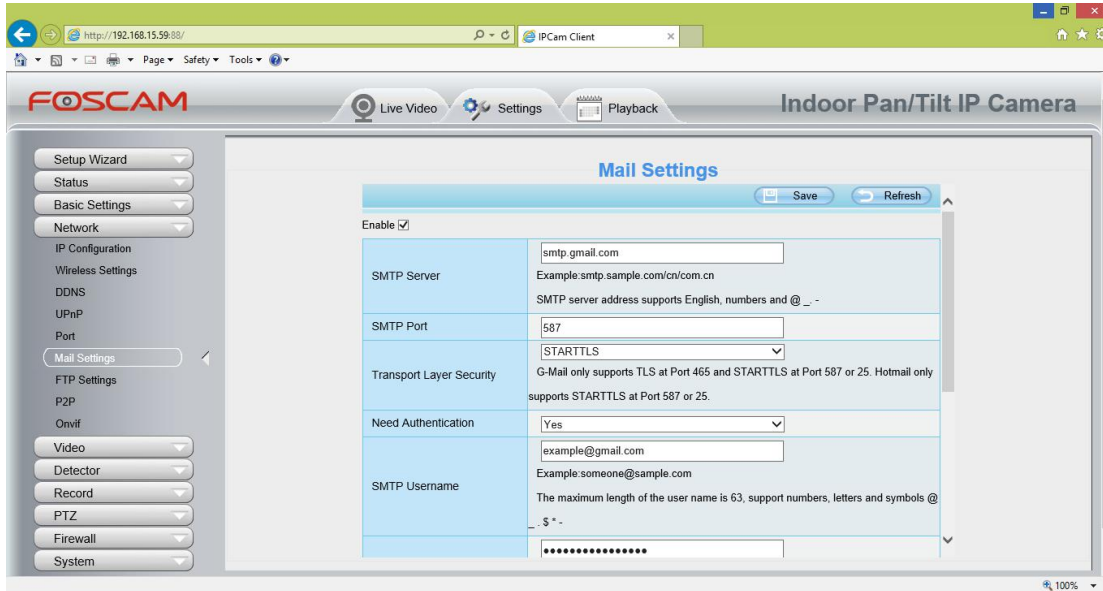

Note:

- (1) Please make sure that your sender email supports SMTP;
- (2) Please click on **Save** before you click on **Test**;
- (3) Make sure the test result is success.
- (4) After succeed, you will receive a test email in the mailbox of Sender.

Step 2: Setup the Motion Alarm Settings

Please go to **Settings > Alarm > Motion Detection** menu:

1. Click **enable**,
2. Choose **Send E-mail** for the alarm action,
3. set your detection area,
4. Set your schedule.

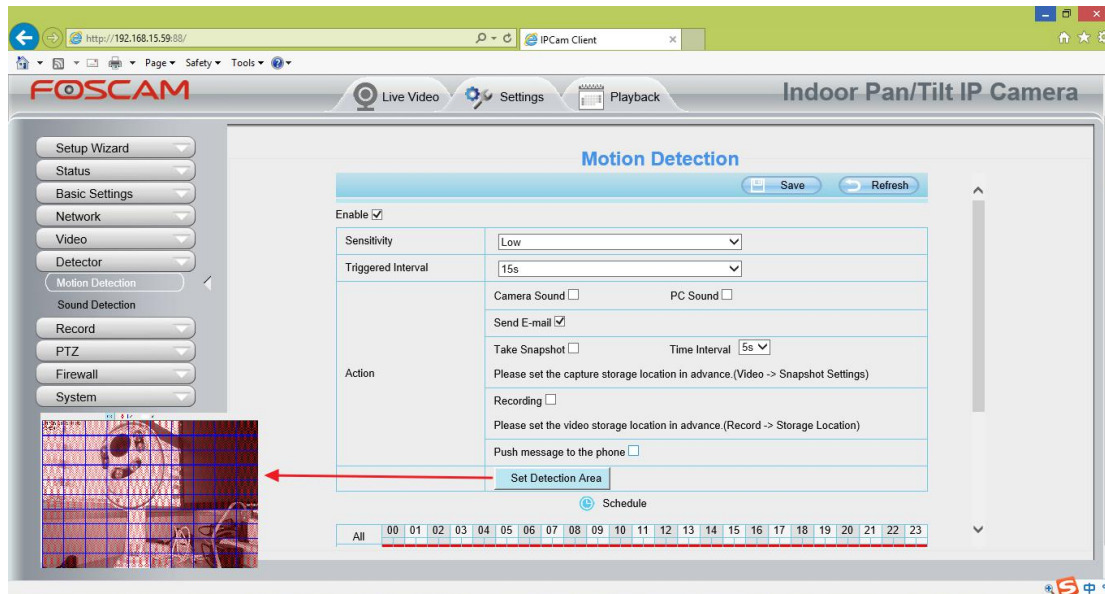

Do not forget to click on **Save** after you finish settings.

If there is motion trigger, camera will alarm and you can receive alarm emails.

Note:

- (1) Please DO NOT forget to set the alarm schedule, the alarm schedule is red.
- (2) Please make sure your camera time is correct.
- (3) Please DO NOT forget to set the alarm area, the detected area is covered by the red grids. Or for some models you can setup 3 detection zones in total.

6.1.7 Camera is not displaying image

Camera unable to show live image on web browser could be caused by multiple factors.

- (1) Plugin is not installed or running properly.

Please install plugin first, go to **IE Browser > Tool > Internet Option > Security > Custom Level > ActiveX control and Plug-ins**. Three options of front should be set to be **Enable**, The ActiveX programs read by the computer will be stored. As follows:

Enable: Download unsigned ActiveX controls.

Enable: Initialize and script ActiveX controls not marked as safe.

Enable: Run ActiveX controls and plug-ins.

- (2) Low network bandwidth that's unable to transfer image. Please lower resolution of the camera.
- (3) IR-cut is stuck at night when IR lights are on. In this case, manually turn off and on IR lights a few times.
- (4) Also, if camera's firmware is too old that doesn't support the browser and unable to install plugin will cause the same issue. Please update firmware of the camera to latest first.

6.1.8 Unable to connect camera remotely using Foscam app

Foscam P2P cameras allow users to connect camera remotely using Foscam app without extract setup like port forwarding. When it unable to connect remotely, below tips can help app establish the connection:

- (1) Update app and camera's firmware to latest version,
- (2) Power off the camera then power back on,
- (3) Delete camera from app then re-add it back, also lower camera's resolution.

6.1.9 Camera is added by others.

When use myfoscam.com cloud or Foscam app, one camera can only be added to one account at the same time. To solve error "This camera has already been added by another account" when add camera to Foscam app or cloud, please send a clear photo of camera's model sticker to Foscam support email support@foscam.com to unbind it.

More FAQs are available here:

<https://www.foscam.com/faqs/index.html>

6.2 Default Parameters

Default Network Parameters

IP Address: obtain dynamically

Subnet Mask: obtain dynamically

Gateway: obtain dynamically

Username and password

Default admin username: admin with a blank password

6.3 Specifications

ITEMS		FI9928P/FI9938B
Image Sensor	Sensor	High Definition Color CMOS Sensor
	Display Resolution	2.0 Megapixel
	Min. Illumination	0 Lux (With IR Illuminator)
Lens	Lens Type	Glass Lens
	focal length	f: 2.8mm ~ 12mm
	Aperture	F1.6
	Diagonal angle of view	48° ~125°
	Horizontal view angle	40° ~ 105°
Video	Image Compression	H.264
	Image Frame Rate	25fps maximum, downward adjustable
	Resolution	1080P (1920 * 1080), 720P(1280 * 720), VGA(640 * 480), QVGA (320 * 240)
	Stream	dual stream
	Image adjustment	The hue, brightness, contrast, saturation, sharpness are adjustable
	Flip image	flip and mirror
	Infrared mode	Automatic or manual
	Pan / Tilt Angle	Horizontal: 355° & Vertical: 78°
	Night visibility	6pcs IR-LEDs, IR range up to 60 metres / 196ft
Audio	Input / Output	External 3.5mm standard interface for two-way audio
	Audio Compression	PCM
Network	Ethernet	One 10/100Mbps RJ45 port
	Wireless Standard	IEEE802.11b/g/n
	Data Rate	IEEE802.11b: 11Mbps (Max.); IEEE802.11g: 54Mbps (Max.); IEEE802.11n: 150Mbps (Max.).
	Frequency bands	2412-2472MHz
	Maximum power	18dBm
	Wireless Security	WEP, WPA, WPA2
	Network Protocol	IP, TCP, UDP, HTTP, HTTPS, SMTP, FTP, DHCP, RTSP, ONVIF
	Remote Access	P2P
	Operating System	Microsoft Windows XP, Vista, 7, 8; Mac OS; iOS, Android

System Requirements	Browser	Microsoft IE; Mozilla Firefox; Google Chrome; Apple Safari.
Other Features	Motion Detection	Alarm via E-Mail, upload alarm snapshot to FTP
	Privacy Zone	Set privacy zone manually
	User Accounts	Three levels user role
	Firewall	Supports IP Filtering
	Reset	Reset button is available
Power	Power Supply	DC 12V / 2.0A
	Power Consumption	10Watts (Max.)
Physical	Dimension (L x W x H)	234mm * 209mm * 138mm / 9.2in * 8.2in * 5.4in
	Net Weight	1850g / 4.1lb
Environment	Operating Temperature	-20°C ~ 60°C (-4°C ~ 140°C)
	Operating Humidity	20% ~ 85% non-condensing
	Storage Temperature	-20°C ~ 60°C (-4°C ~ 140°C)
	Storage Humidity	0% ~ 90% non-condensing
Certification	CE, FCC, RoHS	

Attention: Power adapter should be used between -20°C ~ 40°C, and 20% ~ 90% relative humidity.

6.4 CE & FCC

Electromagnetic Compatibility (EMC)

FCC Statement



This device complies with FCC Rules Part 15. Operation is subject to the following two conditions.

- This device may not cause harmful interference
- This device must accept any interference received, including interference that may cause undesired operation.

This equipment has been tested and found to comply with the limits for a Class A digital device, pursuant to part 15 of the FCC Rules. These limits are designed to provide reasonable protection against harmful interference when the equipment is operated in a commercial environment. This equipment generates, uses, and can radiate radio frequency energy and, if not installed and used in accordance with the instruction manual, may cause harmful interference to radio communications. Operation of this equipment in a residential area is likely to cause harmful interference in which case the user will be required to correct the interference at his own expense.

FCC Caution

Any changes or modification not expressly approved by the party responsible for compliance could void the user's authority to operate this equipment.

This equipment complies with FCC radiation exposure limits set forth for an uncontrolled environment.

This equipment should be installed and operated with minimum distance 20cm / 7.9in between the radiator & your body.

This transmitter must not be co-located or operating in conjunction with any other antenna or transmitter.

CE Mark Warning



This is a Class A product. In a domestic environment, this product may cause radio interference, in which case the user may be required to take adequate measures.

6.5 Warranty

FOSCAM values your business and always attempts to provide you the very best of service.

No limited hardware warranty is provided by FOSCAM unless your FOSCAM product ("product") was purchased from an authorized distributor or authorized reseller. Distributors may sell products to resellers who then sell products to end users. No warranty service is provided unless the product is returned to an authorized return center in the region where the product was first shipped by FOSCAM or to the point-of-purchase, which may have regional specific warranty implications.

If you purchase your FOSCAM product from online store, please contact the point-of-purchase and ask for return / replacement / repair service.

Limited Hardware Warranty

FOSCAM products are warranted to be free from manufacturing defects in materials and workmanship starting from the shipping date of FOSCAM.

This limited hardware warranty does not cover:

- Software, including the software added to the products through our factory-integration system, software, etc.
- Usage that is not in accordance with product instructions.
- Failure to follow the product instructions.
- Normal wear and tear.

Return Procedures

- Please read FOSCAM warranty policy & policy of your reseller first before sending items back to point-of-purchase.
- Customer must first contact point-of-purchase to obtain a Return Merchandise Authorization (RMA) number before returning the product. If the product you received is suspected to be defective and the product warranty has not expired, The RMA number will allow your reseller to track your return much easier and help them expedite processing your request.
- After receiving your RMA case number, pack the item(s) very well with the original box and all the original accessories included such as power adapters, brackets, cables, manuals.
- Write your RMA number and the return reason (the problem of the product) on the warranty card along with the complete package to send them back.

Replacement Services

- **If customers ask for replacement service, please contact point-of-purchase and follow their policy.**
- Our technicians will inspect all items returned for replacement requests. If the returned product is found in working order, we will return the same item received. However customers shall be responsible for all shipping & handling charges incurred for getting the units back to customers.
- If returned products are found defective, we will replace the product and assume the shipping cost for sending back the replacement unit to customers.
- If for any reason, we are unable to provide a replacement of the original returned item(s). You will have a choice for a "Substitute" item at the same equal value.
- We do not provide exchange and replacement due to normal hardware upgrade according the market after 14 days after the product is delivered.

-
- Our technicians will test the product before send out the replacement, any other demand for more than two times replacement for the same product during replacement limit will be rejected.
 - **Replaced products are warranted from the balance of the former warranty period.**

Warranty Forfeiture

- Warranty is void if purchase from unauthorized distributor or reseller.
- **Warranty is void if trade-mark, serial tags, product stickers have been removed, altered or tampered with.**
- Warranty is void for mishandling, improper use, or defacing the product.
- Warranty is void for physical damage, altered, either internally or externally, improper or inadequate packaging when returned for RMA purposes.
- Warranty is void if damage has resulted from accident, dismantle, abuse, or service or modification by someone other than the appointed vendor, souse, fission or the spare part has been over the period of warranty.
- Warranty is void if product is damaged due to improper working environment or operation. (For example, improper temperature, humidity, unusual physical or electrical stress or interference, failure or fluctuation of electrical power, static electricity, using wrong power adapter, etc.)
- Warranty is void if damaged by the use of parts not manufactured or sold by FOSCAM.
- Damage caused by improper installation of third-party products.
- Warranty is void if damaged for irresistible cause, such as earthquake, fire, lightning, flood, etc.
- Product beyond limited warranty.

Shipping Fee

- If products are defective or damaged under normal use or operation in the replacement limit, distributors or resellers are responsible for the shipping cost the product back to customers, customers should assume the shipping cost send the product to the point-of-purchase.
- During replacement limit, if customers ask for replacement due to the product does not fit for customer's personal expectation, customers should responsible for both shipping fee.
- Customers shall be responsible for both shipping fee if their product beyond the replacement limit but still in warranty limit.

Repair Service Out Of Warranty

- FOSCAM provide extra repair service for product that out of warranty, it is chargeable. The total fee contains device cost and service fee. Device cost (including accessories) is the standard uniform price provide by FOSCAM.
- Different region may have different service fee, please contact the point-of-purchase to confirm that before you ask for this service.
- Our technicians will quote the total price after detect the product, If customers refused to repair after the quotation, customers need pay for the test fee, \$3.5 / hour. If agree with the quotation, test will be free.
- Repaired product out of warranty will obtains 3-month warranty from the date of the product back to customers.

Limitation of Liability

- FOSCAM is not responsible for other extra warranty or commitment promised by resellers, if your reseller promised some extra commitment or warranty; please ask for written documents to protect your rights and interests.

-
- FOSCAM does not offer refunds under any circumstances. Please contact the point-of-purchase and follow their refund / return policy.
 - FOSCAM shall not be liable under any circumstances for any consequential, incidental, special or exemplary damages arising out of or in any connection with this agreement or the products, including but not limited to lost profits, or any claim based on indemnity or contribution, or the failure of any limited or exclusive remedy to achieve its essential purpose or otherwise. Purchaser's exclusive remedy, as against FOSCAM, shall be the repair or replacement of defective parts. If FOSCAM lists a product on its website specification in error or that is no longer available for any reason, FOSCAM reserves the right to explain it without incurring any liability.

All rights reserved. FOSCAM and the FOSCAM logo are trademarks of ShenZhen FOSCAM Intelligent Technology Limited., registered in the U.S. and other countries.

6.6 Statement

You are advised to be cautious in daily life, keep personal account information carefully, do not share personal account easily. Change passwords of your account and equipment periodically, and upgrade equipment firmware to strengthen security consciousness.

Our company makes no warranty, implied or otherwise, that this product is suitable for any particular purpose or use. You need to abide by the relevant laws and regulations of the use restrictions when using Foscam cameras. Our company takes no responsibility of illegal activities by using our products.

Our company takes no responsibility of the loss by force majeure, such as failure or faults of telecom system or the Internet network, computer viruses, malicious attacks of hackers, information damage or loss, and faults of computer system.

Foscam company does not need to take any responsibility of the special, incidental or corresponding loss by the products of our company or any software provide by our company, including but not limited to operating loss, profit or purpose. The company only takes the responsibility applicable to national and local legal requirements.

Our company takes no responsibility of the loss caused by the following at ant time:

- 1) loss of purchases;
- 2) loss of intangible property damage, such as data, programs;
- 3) loss of compensation claimed by third-party customers.

Delete images, format the memory card or other data storage devices does not completely remove the original image data. You can restore deleted files from discarded the storage device by commercial software, but which will potentially lead to personal image data used maliciously by others. The privacy of the data security belongs to user responsibility, the company takes no responsibility.

Parts mentioned in this statement should not be understood by the configuration description of the product purchased by the customer, the product configuration must accord to the specific models purchased by the customer.

Without the prior written permission of Foscam company, all the contents of relevant operating instructions manual affiliated to the product must not be reproduced, transmitted, transcribed or stored in a retrieval system, or translated into other languages.

Our company will reserve the right to improve and modify the product and corresponding manuals. The company reserves the right of final interpretation on our products.

7 Obtaining Technical Support

While we hope your experience with the IP camera network camera is enjoyable and easy to use, you may experience some issues or have questions that this User's Guide has not answered.

If you have problem with FOSCAM IP camera, please first contact FOSCAM reseller for solving the problems.

If our reseller cannot provide service, please contact our service department: support@foscam.com.



CE Certificate statement Website: <https://www.foscam.com/company/ce-certificate.html>

[https://www.foscam.com/Images/ce/DeclarationofConformitydownload\(Germany\).pdf](https://www.foscam.com/Images/ce/DeclarationofConformitydownload(Germany).pdf)

Exporter and Importer Information Opened to Public: <https://www.foscam.com/company/open-information.html>

Manufacturer: Shenzhen Foscam Intelligent Technology Co., Ltd

Addr: 9/F, Block F5, TCL International E City, No.1001

ZhongShanyuan Rd., NanShan District, Shenzhen, China, 518055